

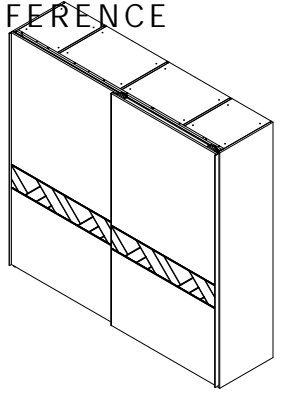

IMPORTANT - READ CAREFULLY - RETAIN FOR FUTURE REFERENCE  
 WICHTIG - SORGFÄLTIG LESEN UND AUFBEWAHREN

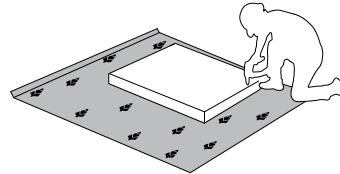

**PK231/AV**  
 LWH - 2294x611x2236

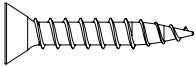
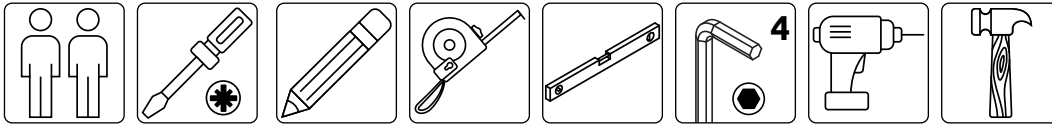

<b>x42</b> 2149 	<b>x32</b> 0063 Ø15x13 	<b>x8</b> 0064 Ø8x24 	<b>x48</b> 16535 	<b>x16</b> 0102 	<b>x32</b> EKSK4-BE 	<b>x2</b> 2114 4x35 	<b>x90</b> 0094 3.5x16 	<b>x68</b> 31777 4.2x16 	<b>x13</b> 0096 4x18 	
<b>x2</b> 1321 	<b>x4</b> 31533 	<b>x2</b> 36918 	<b>x2</b> 26102 	<b>x1</b> 46945 	<b>x1</b> 46948 	<b>x1</b> 0113 GLUE 				
<b>x2</b> 32286 	<b>x1</b> 46950 	<b>x10</b> NPVC75 	<b>x1</b> 46953 							
<b>x28</b> CEP8 	<b>x48</b> FAH-16 	<b>x50</b> 0122 	<b>x12</b> 32245 							
<b>x8</b> 0104 	<b>x2</b> 10397 									
<b>x42</b> 36894 										

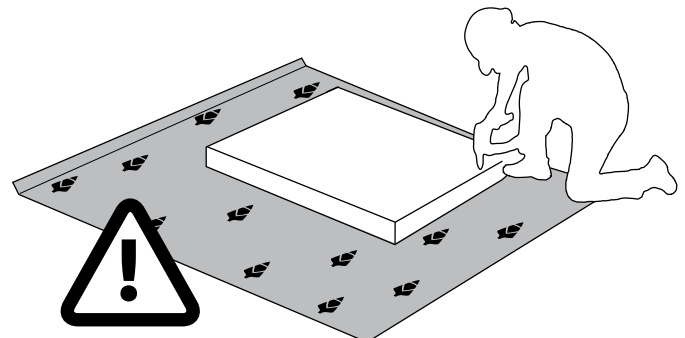

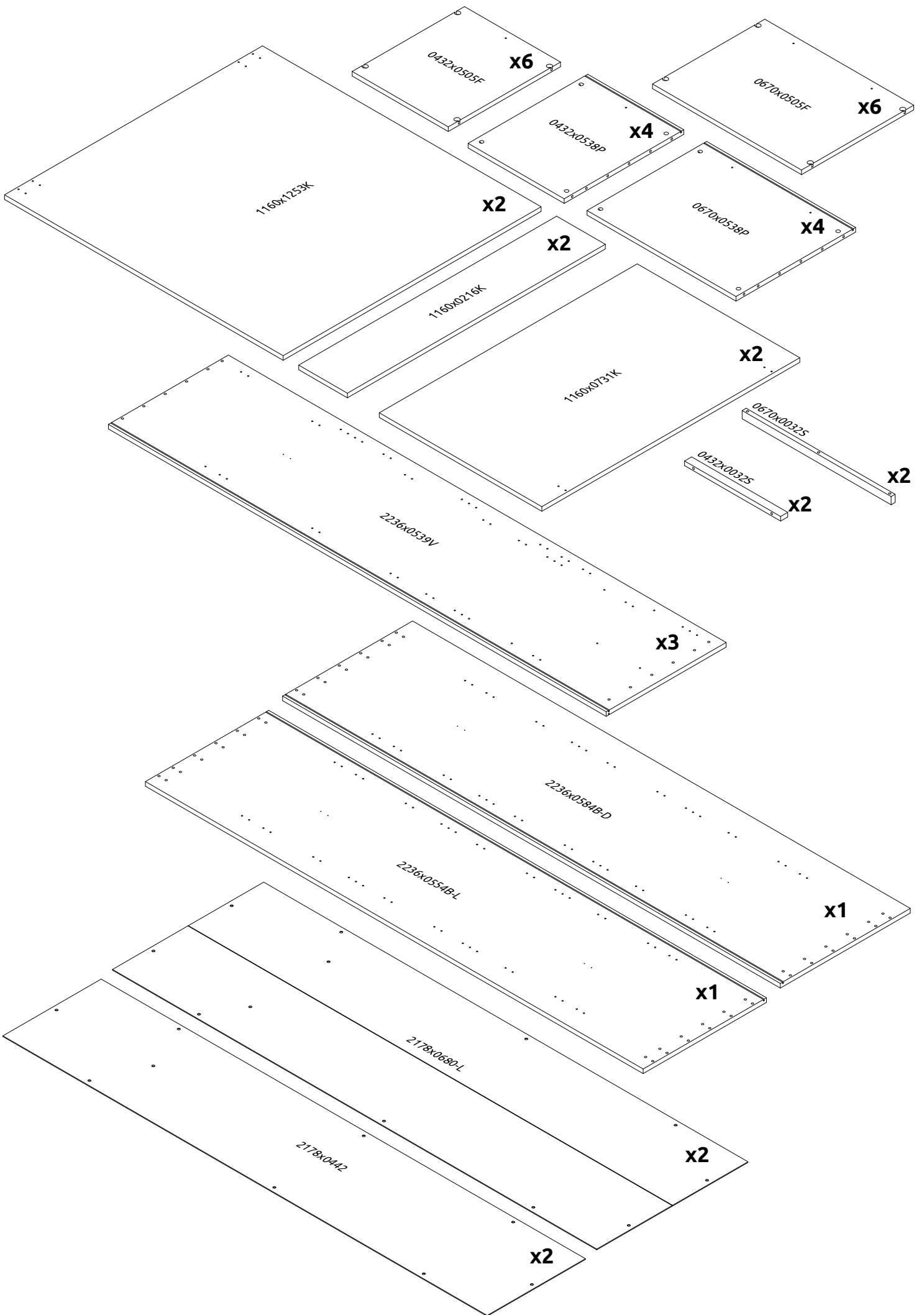

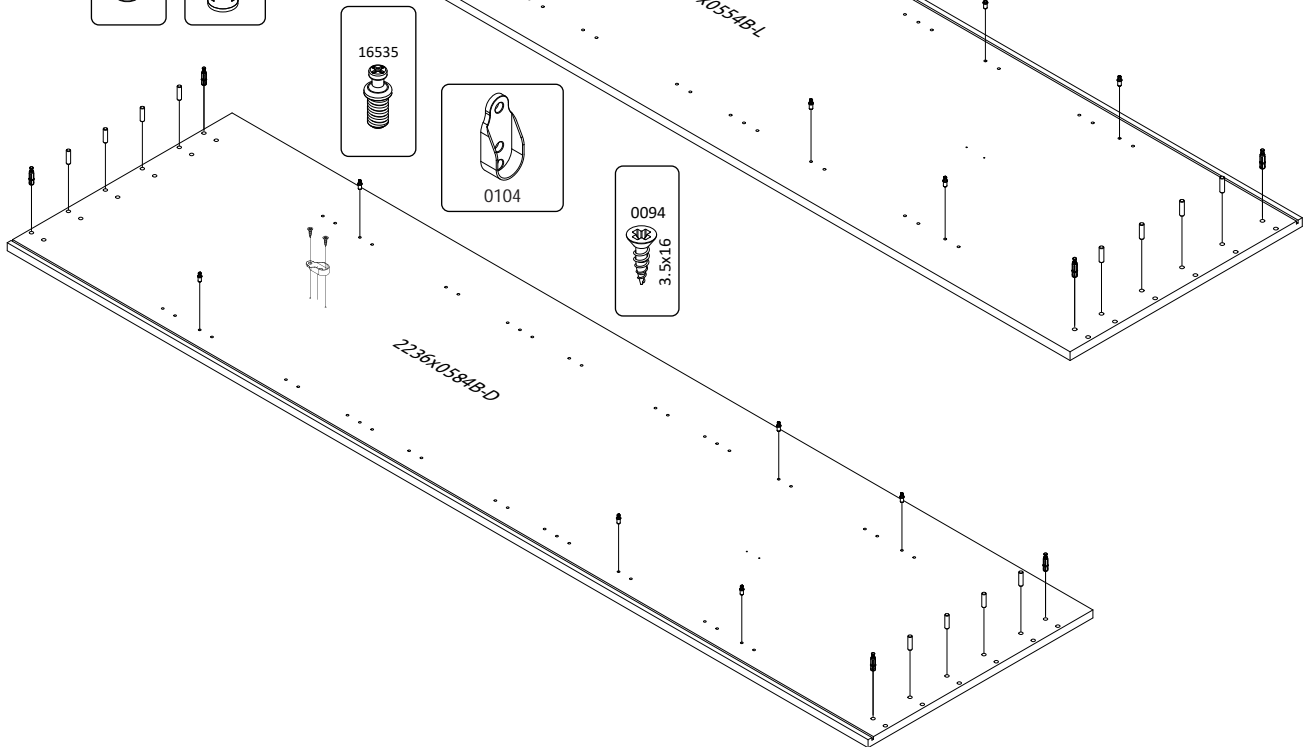
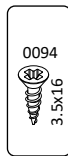
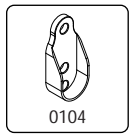
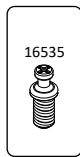
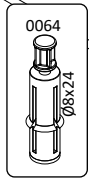
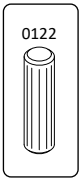
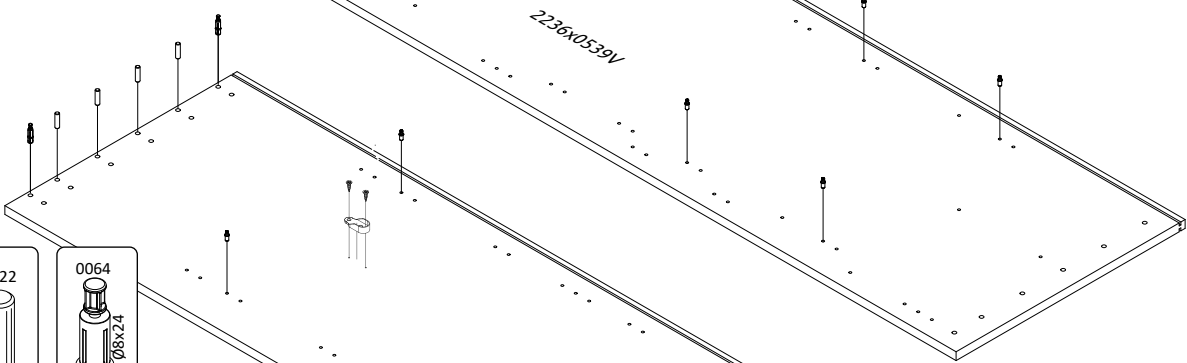
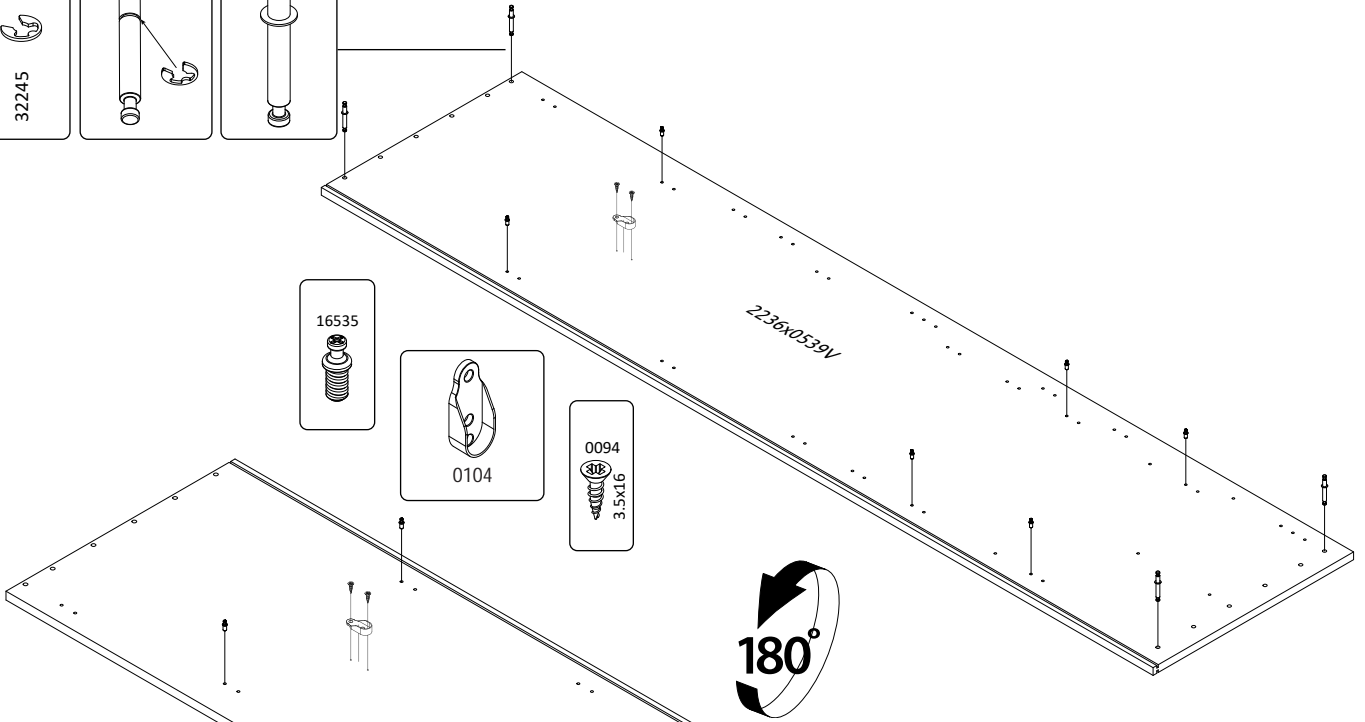
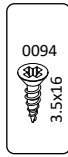
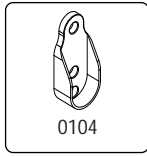
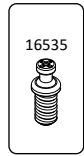
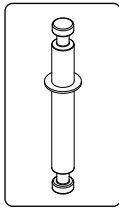
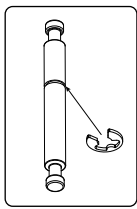
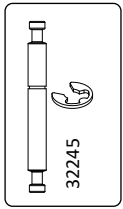

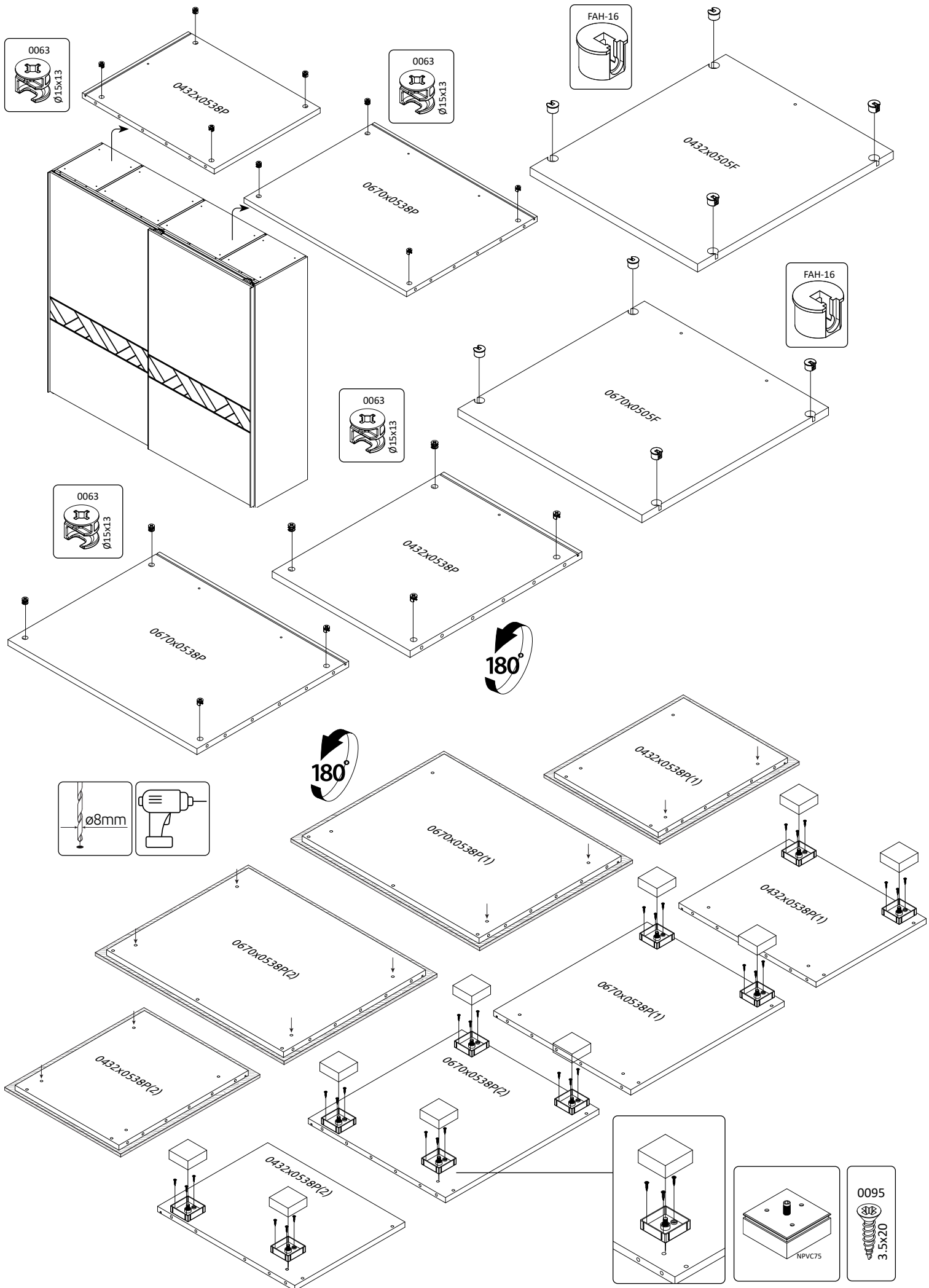

1

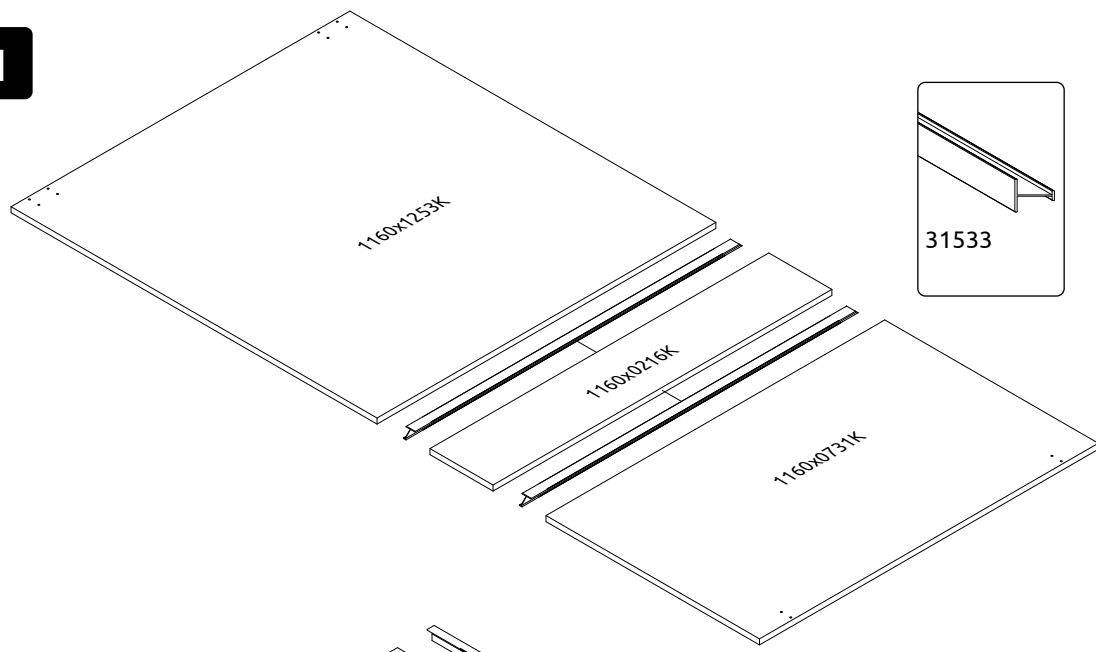

2

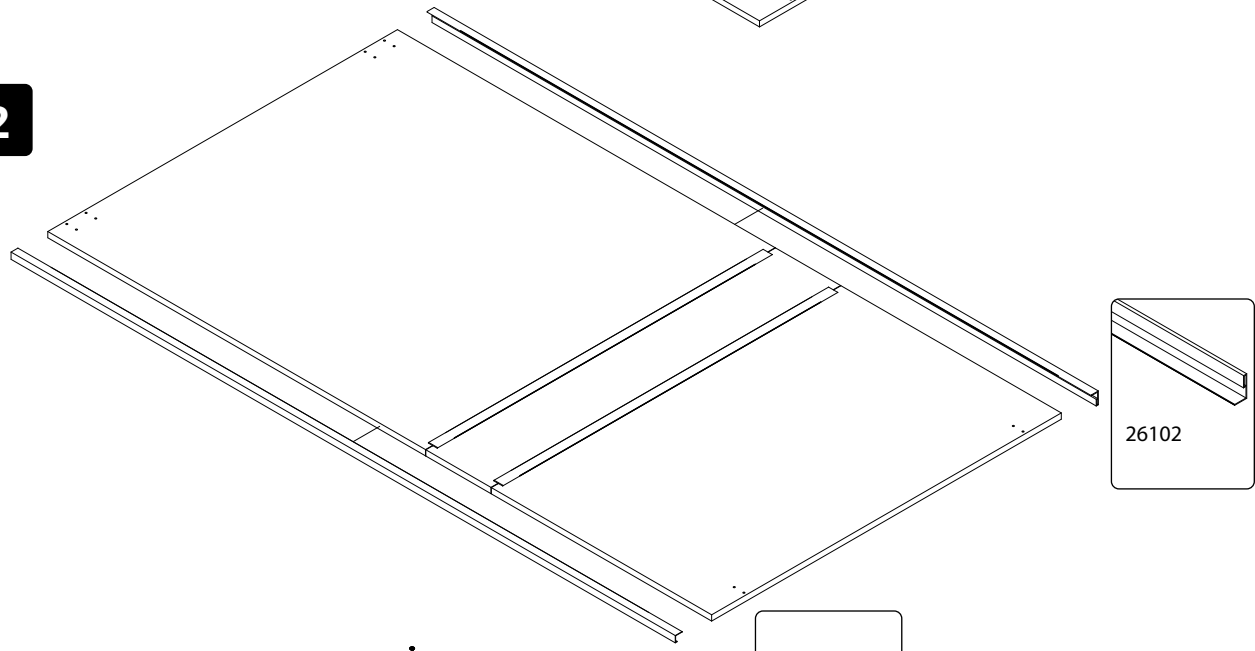

3

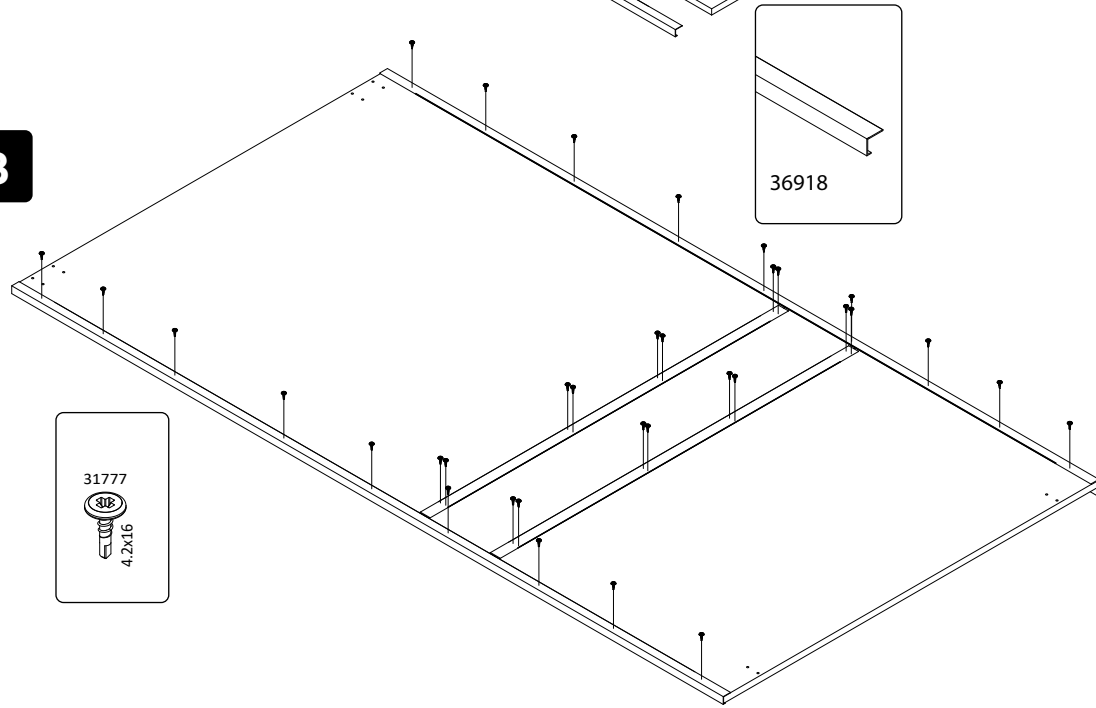

4

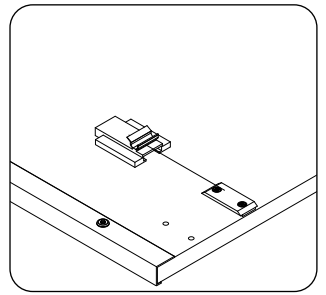
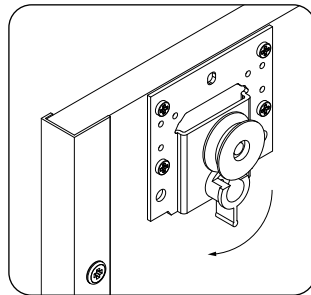
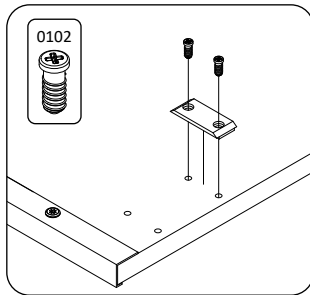
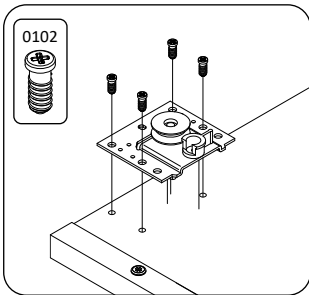
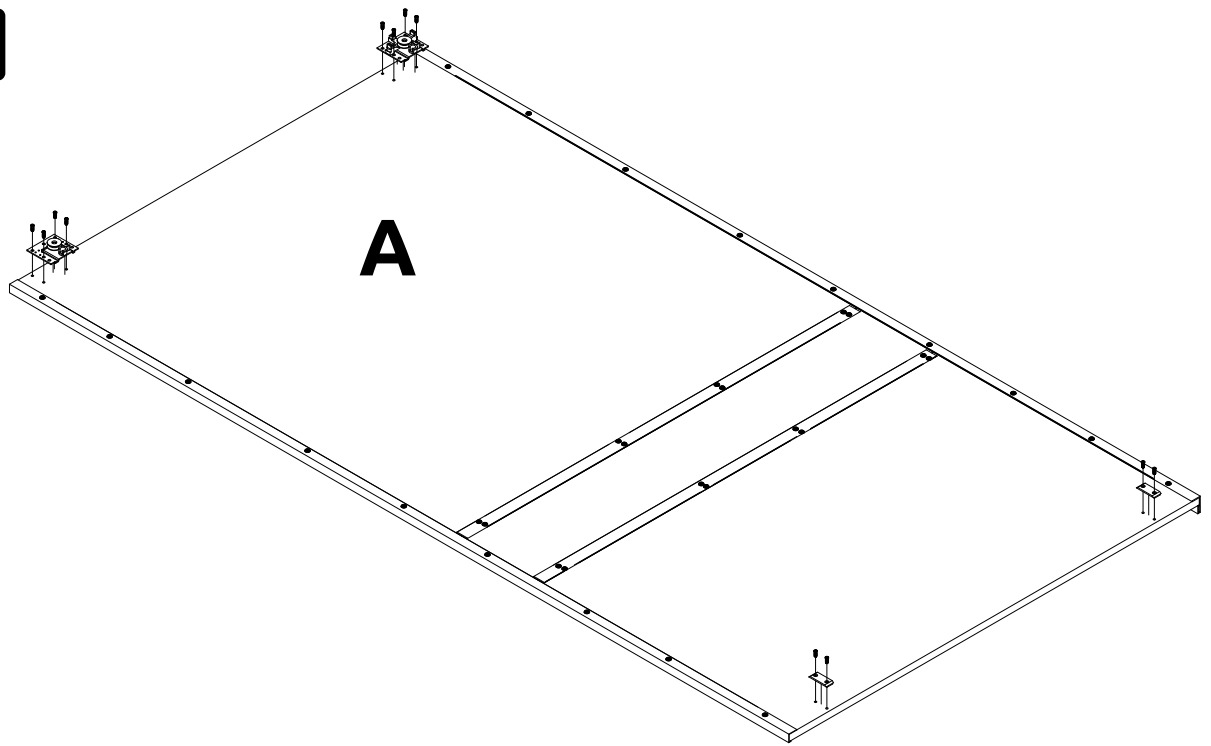

5

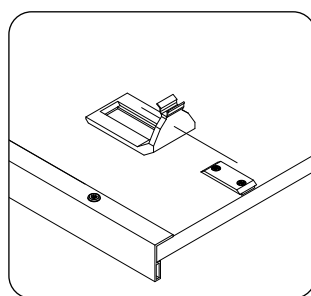
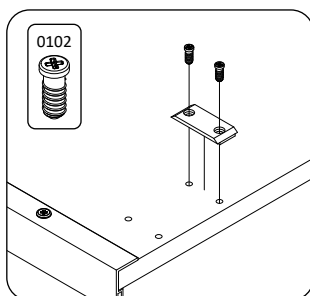
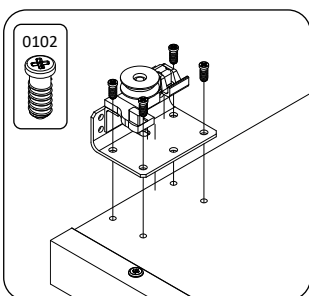
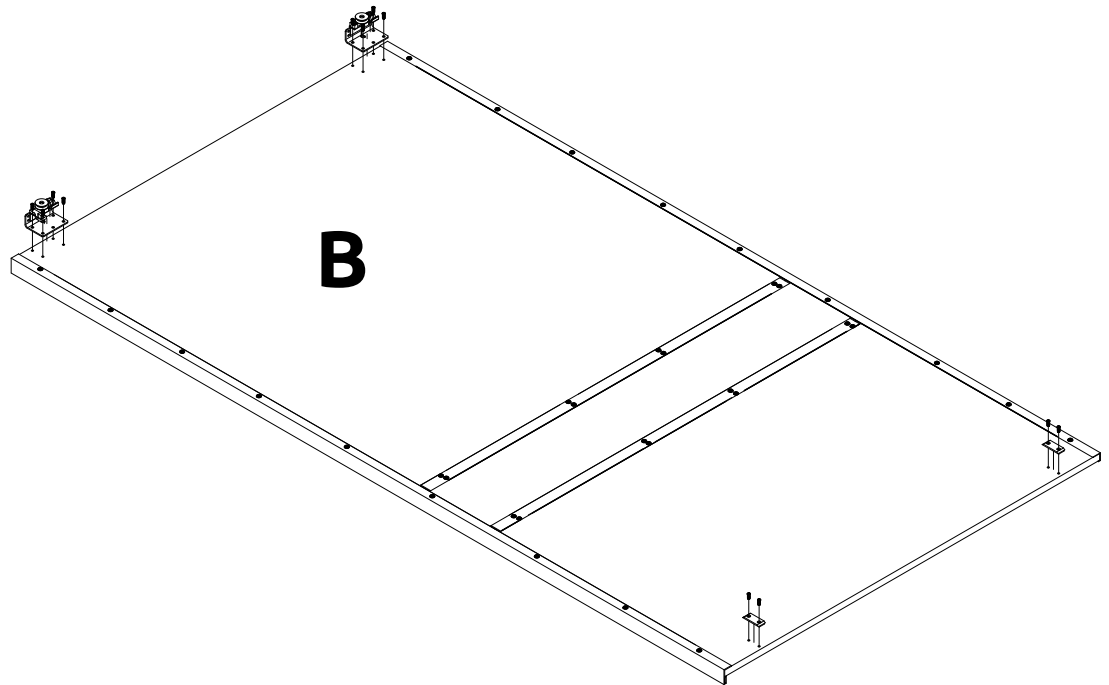

6

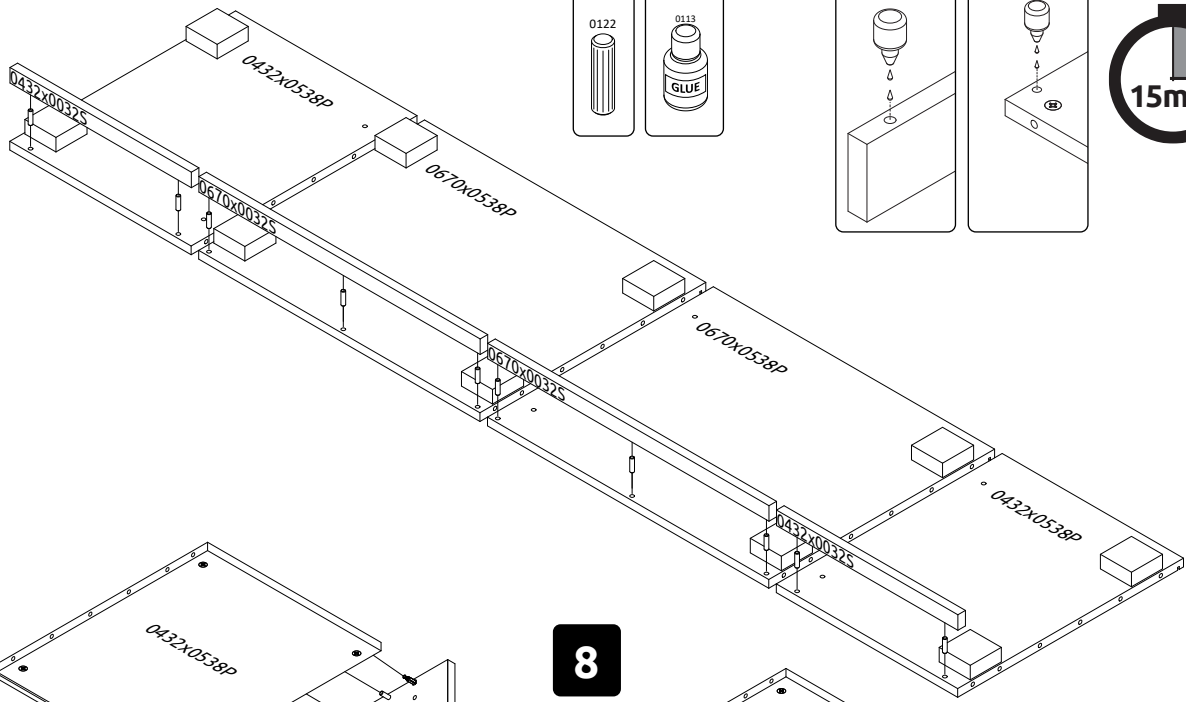

7

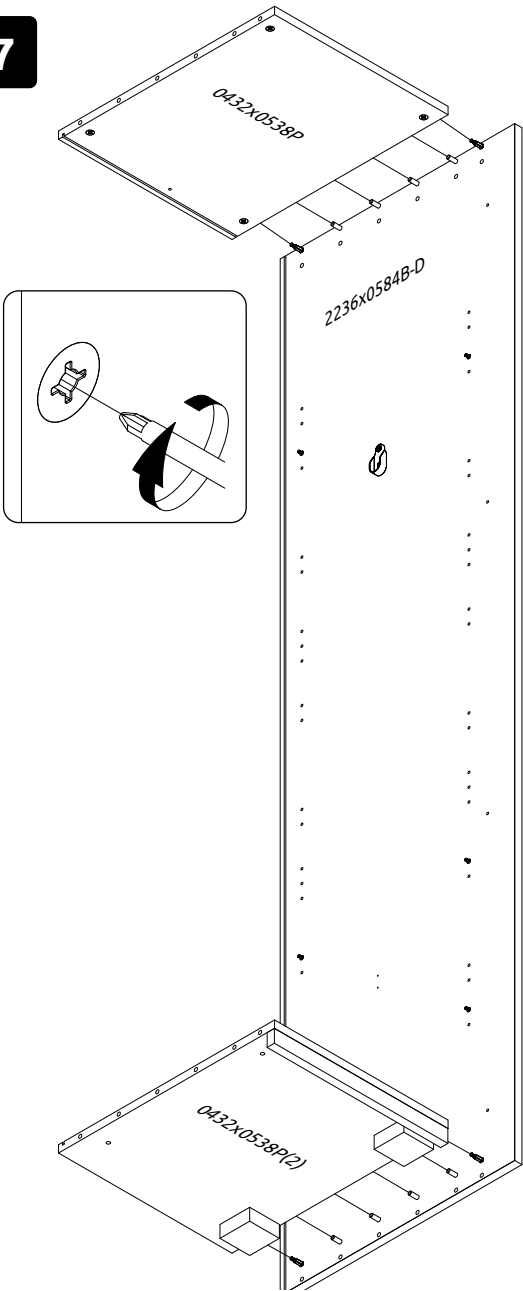

8

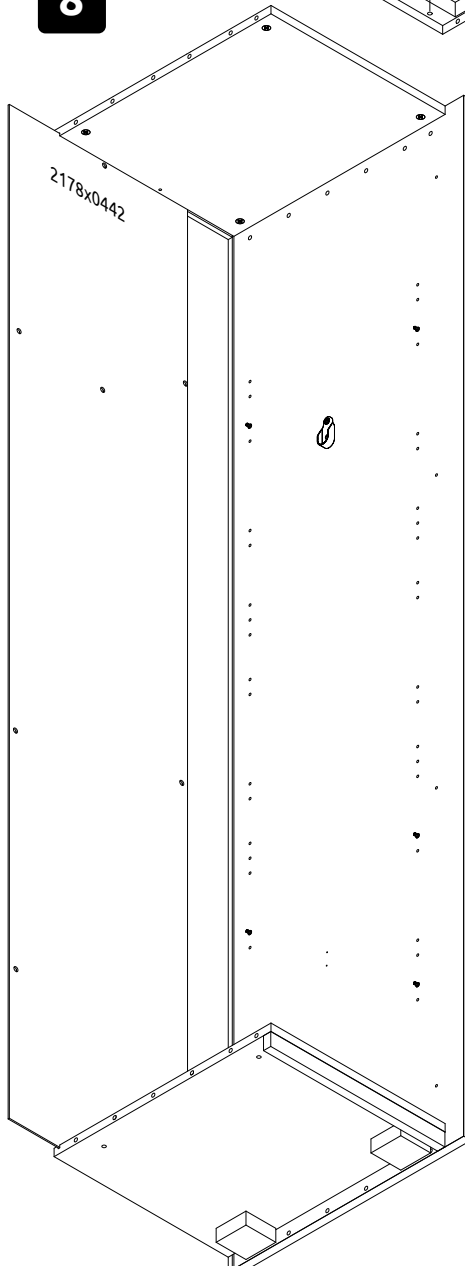

**9**

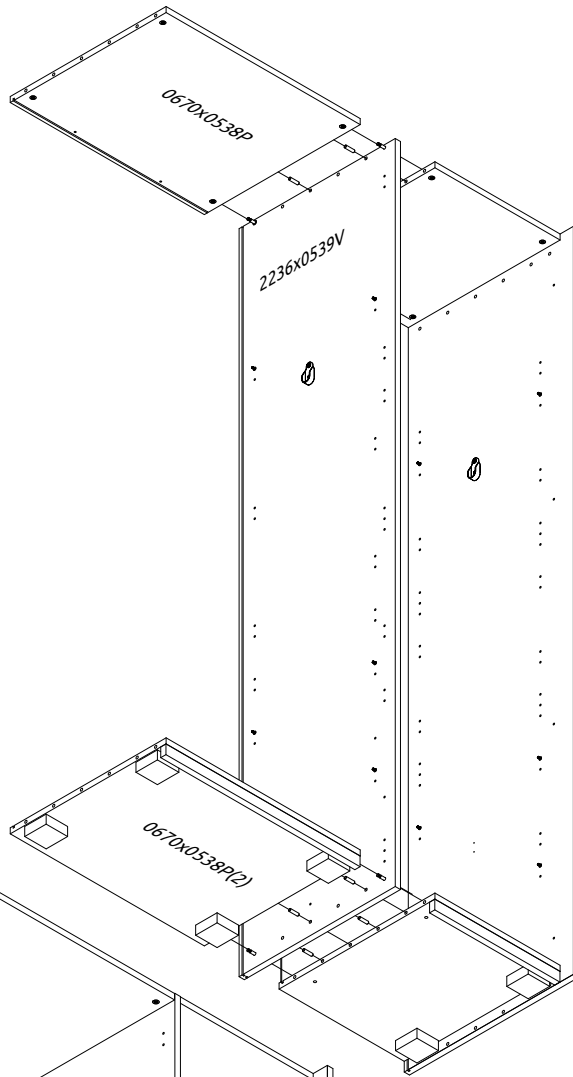
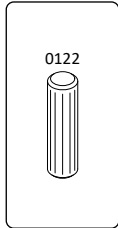
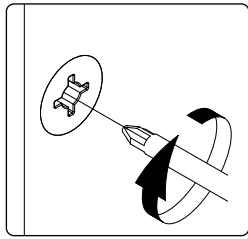

**10**

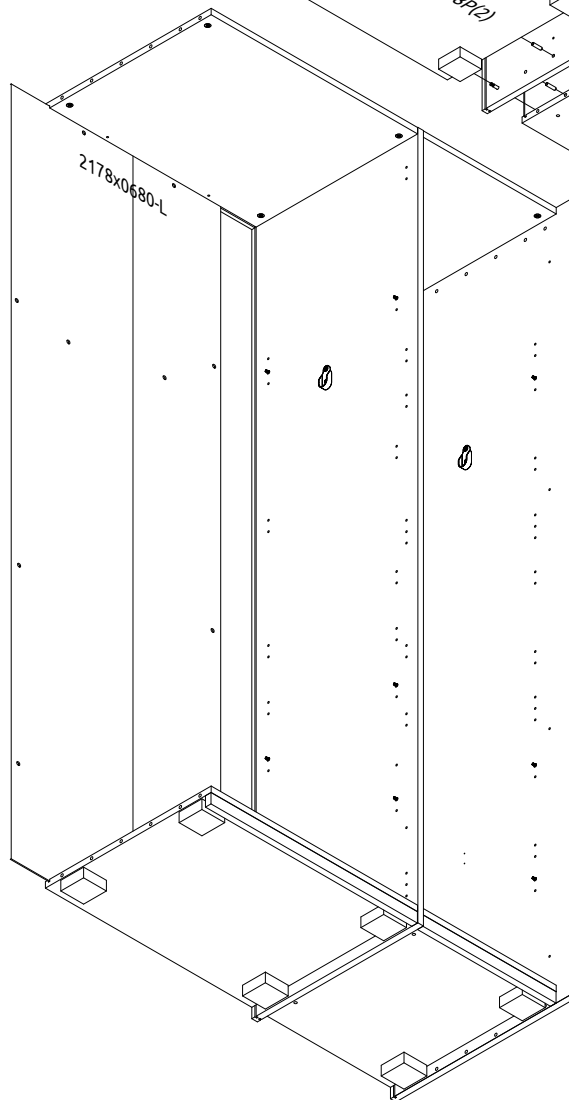



11

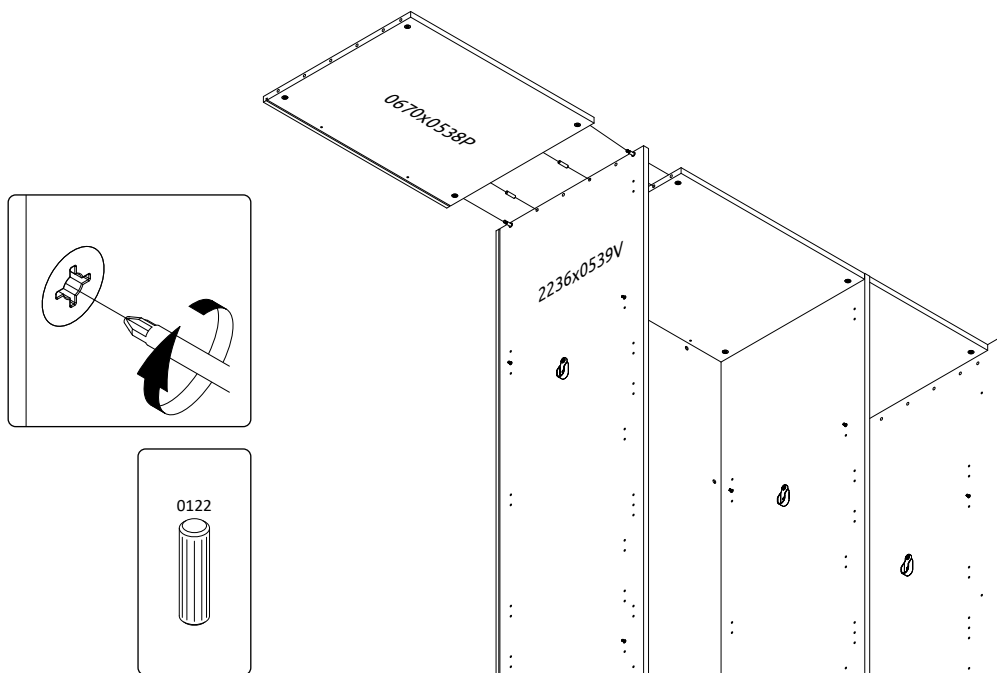

12

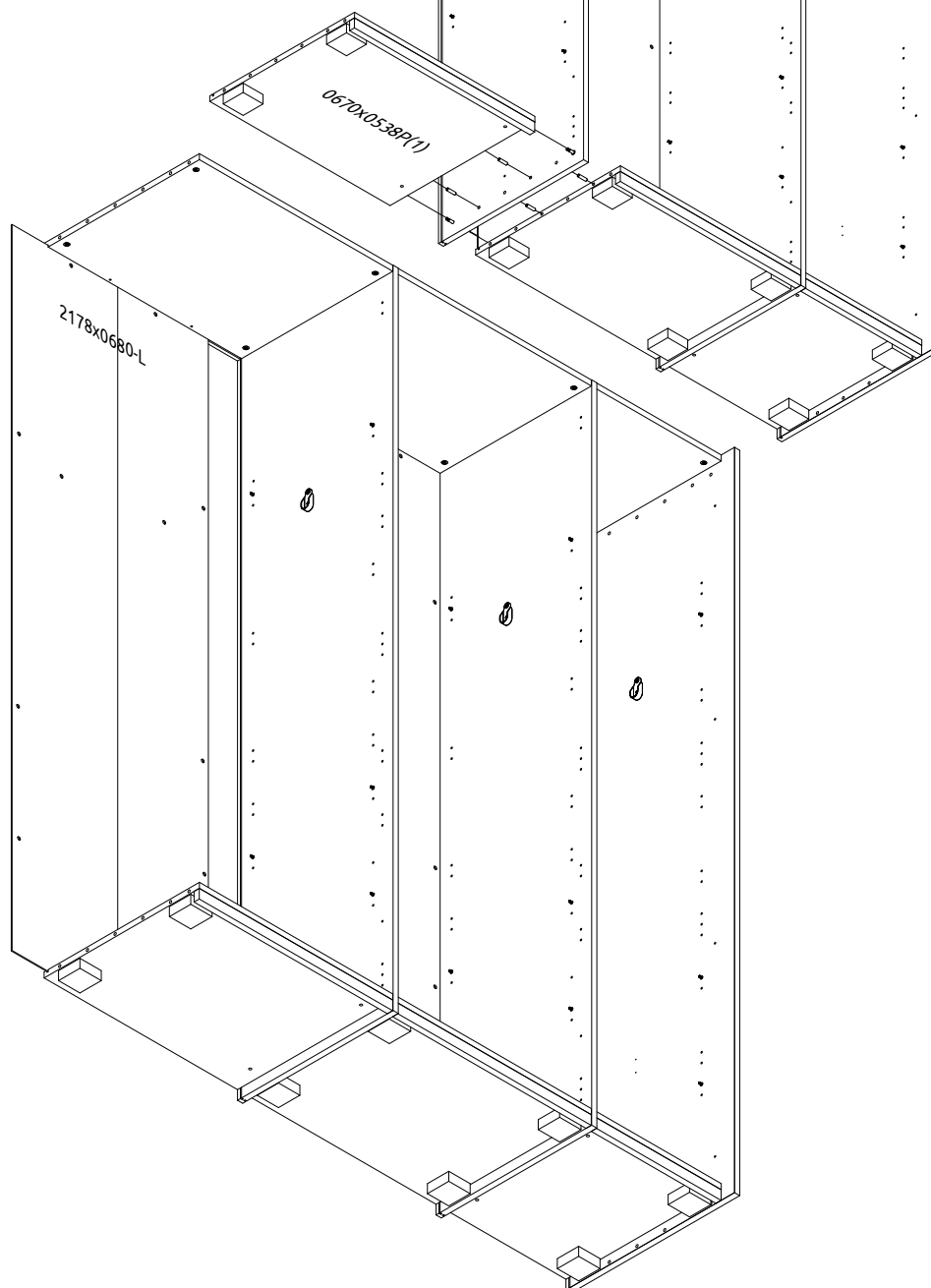

13

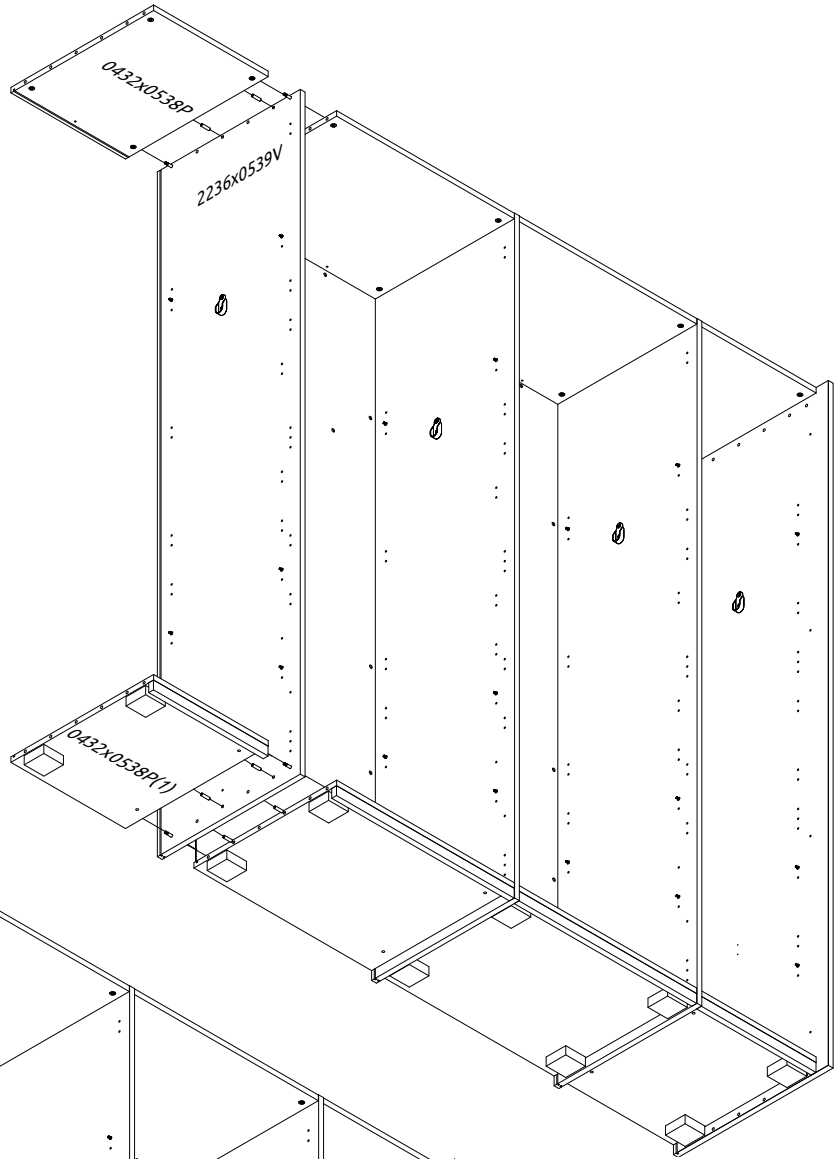
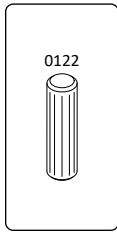
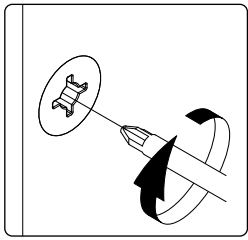

14

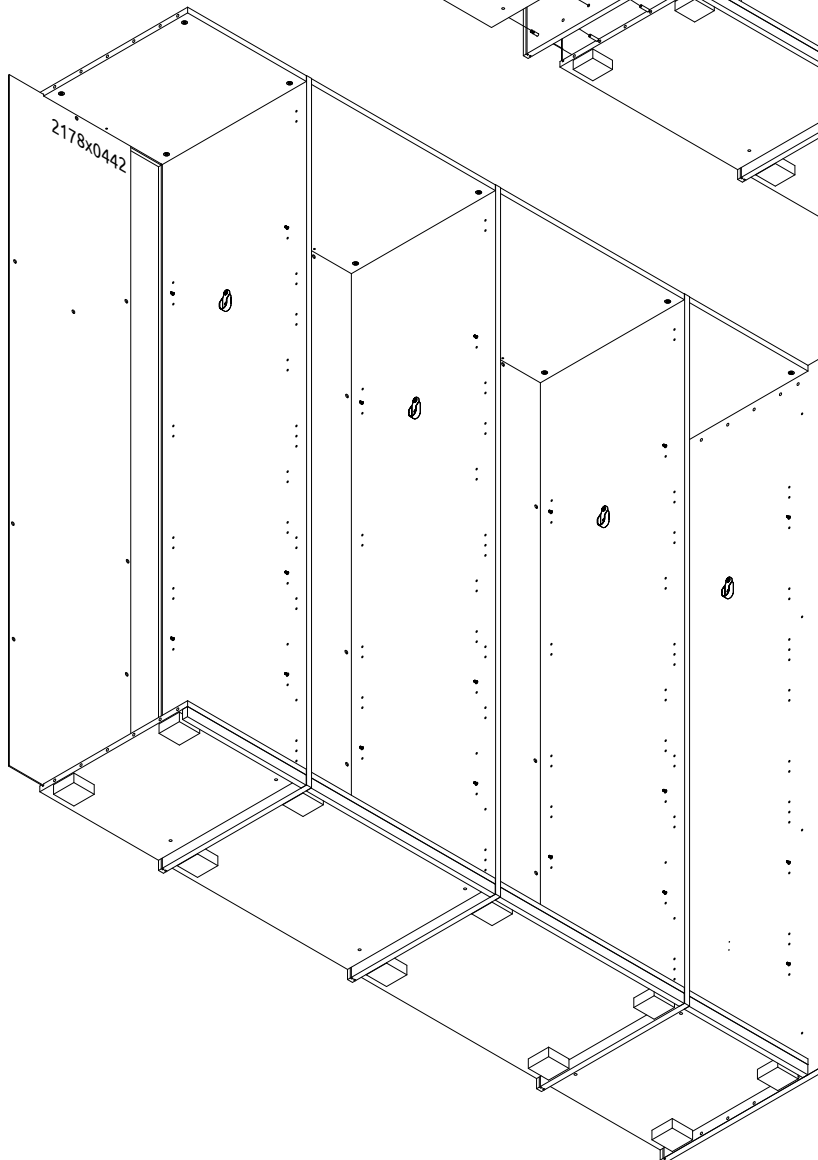

15

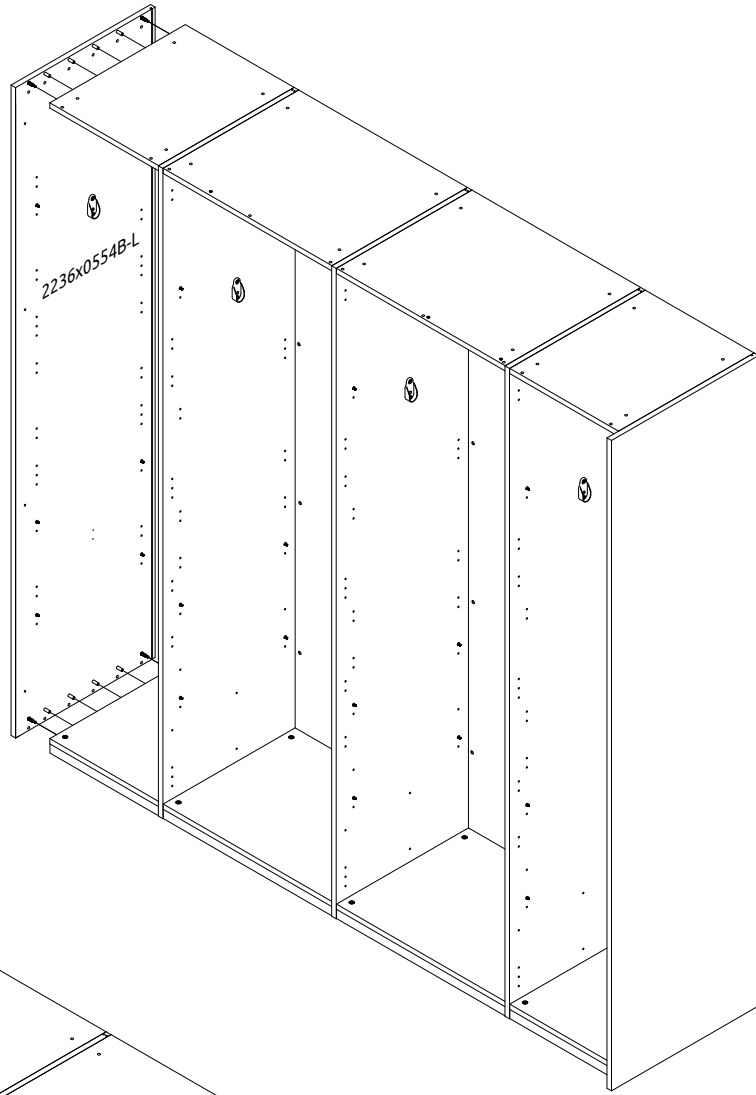
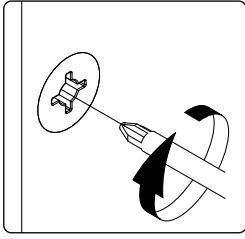

16

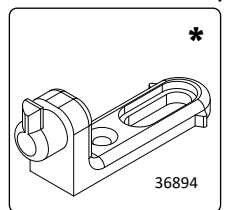
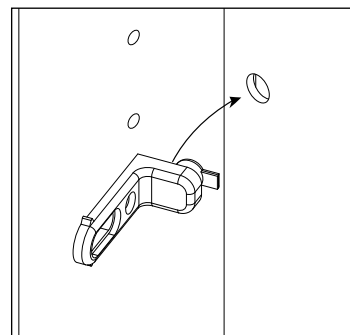
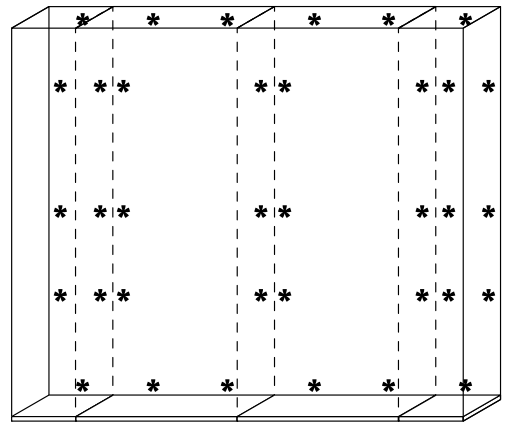
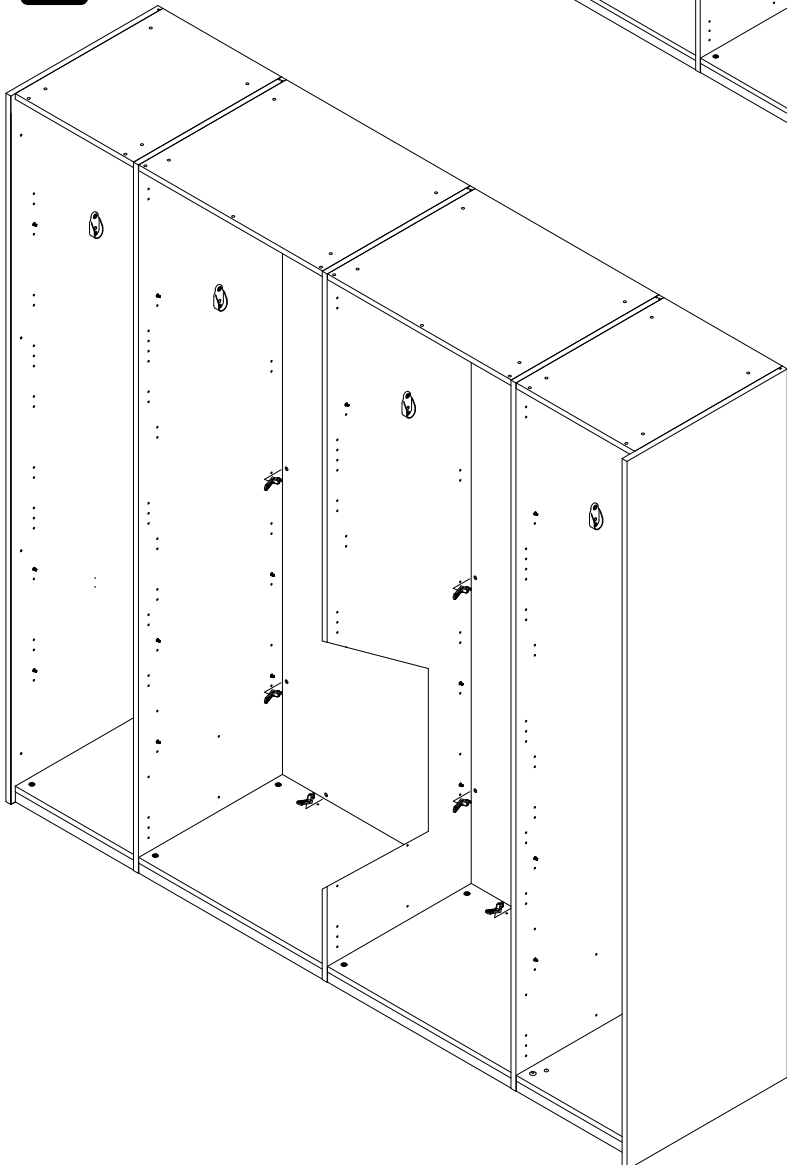

17

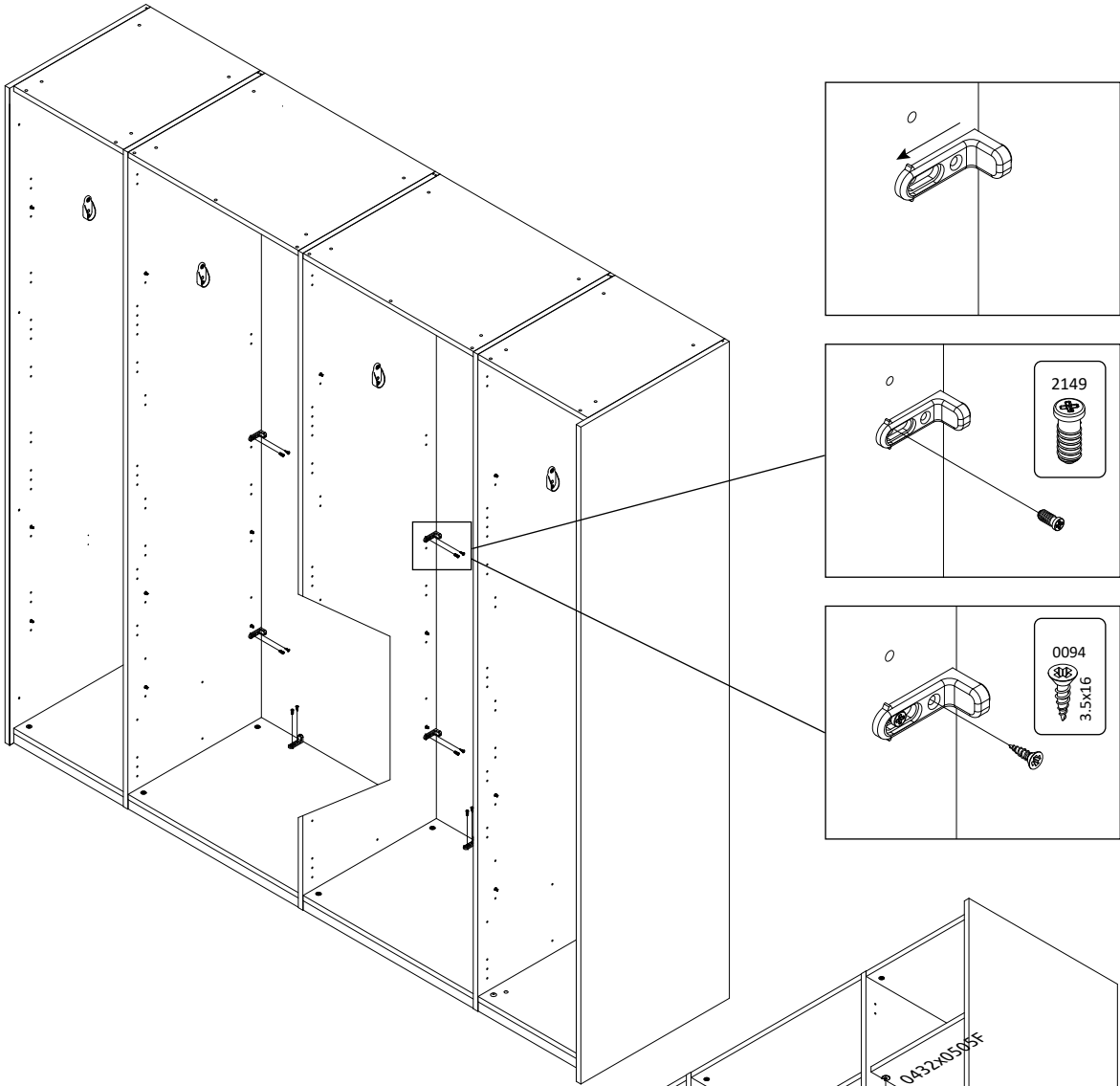

18

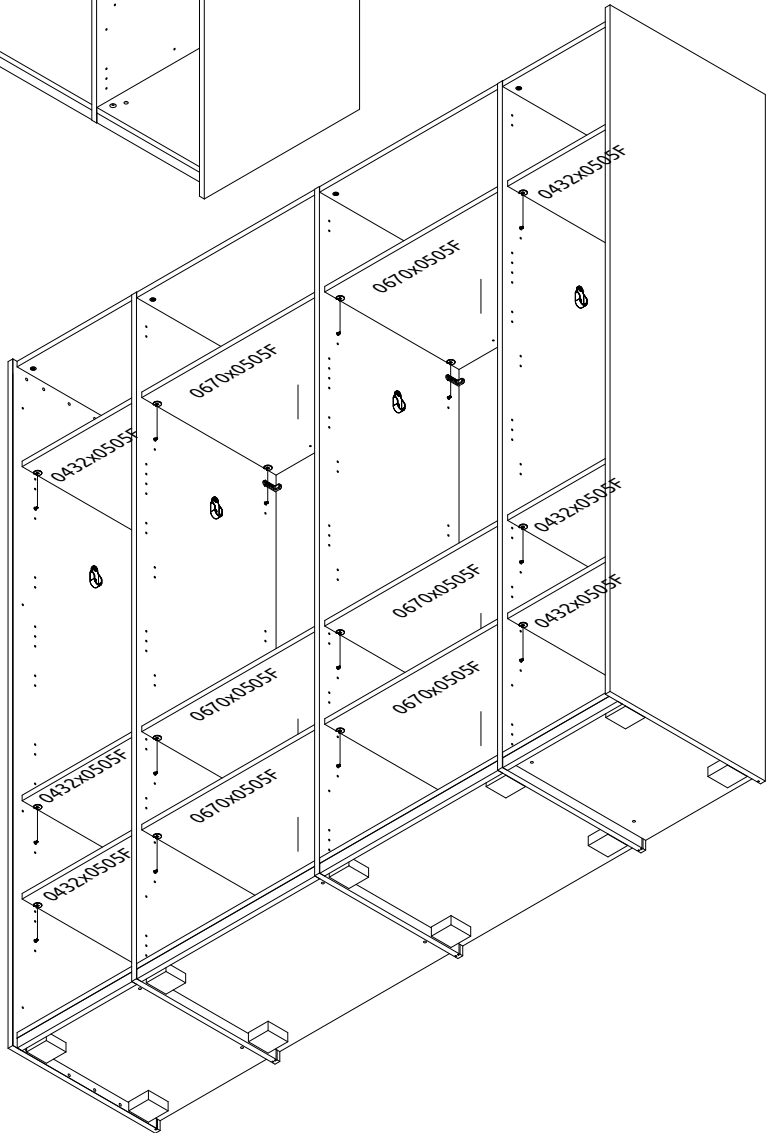

19

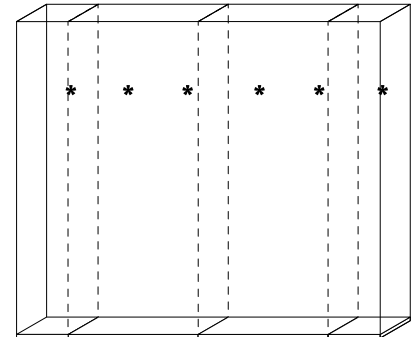
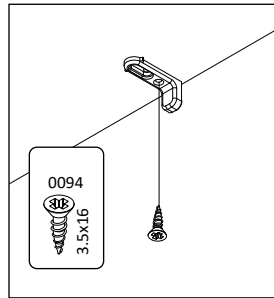
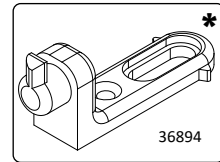
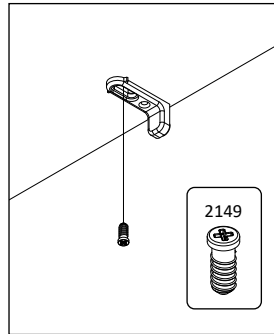
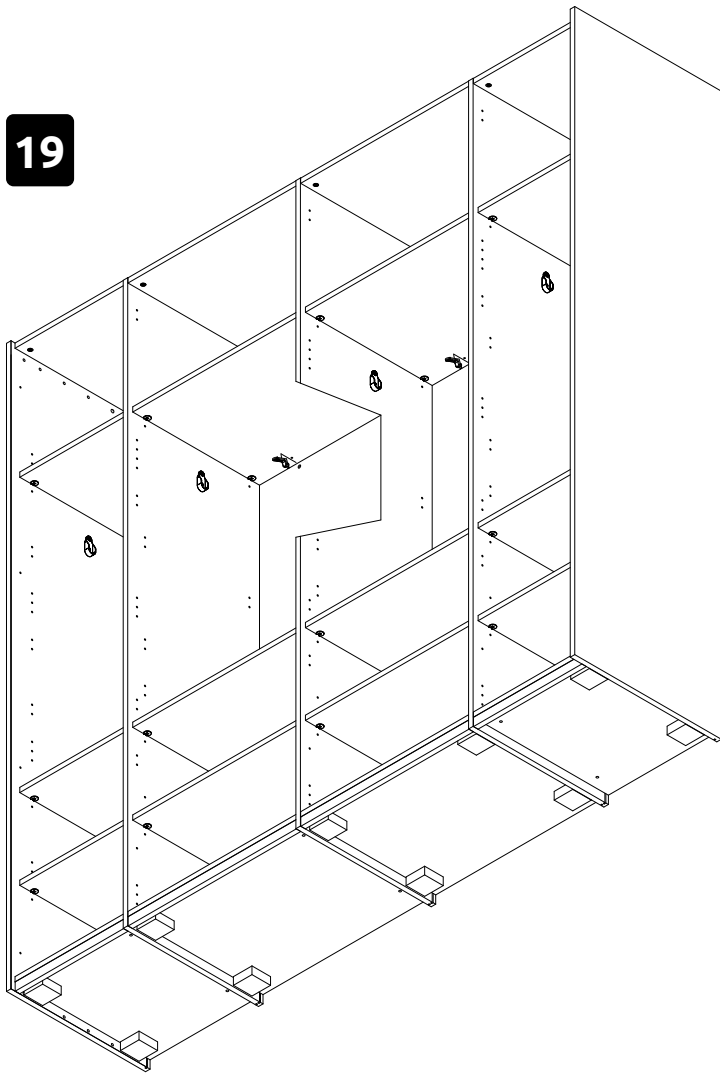

20

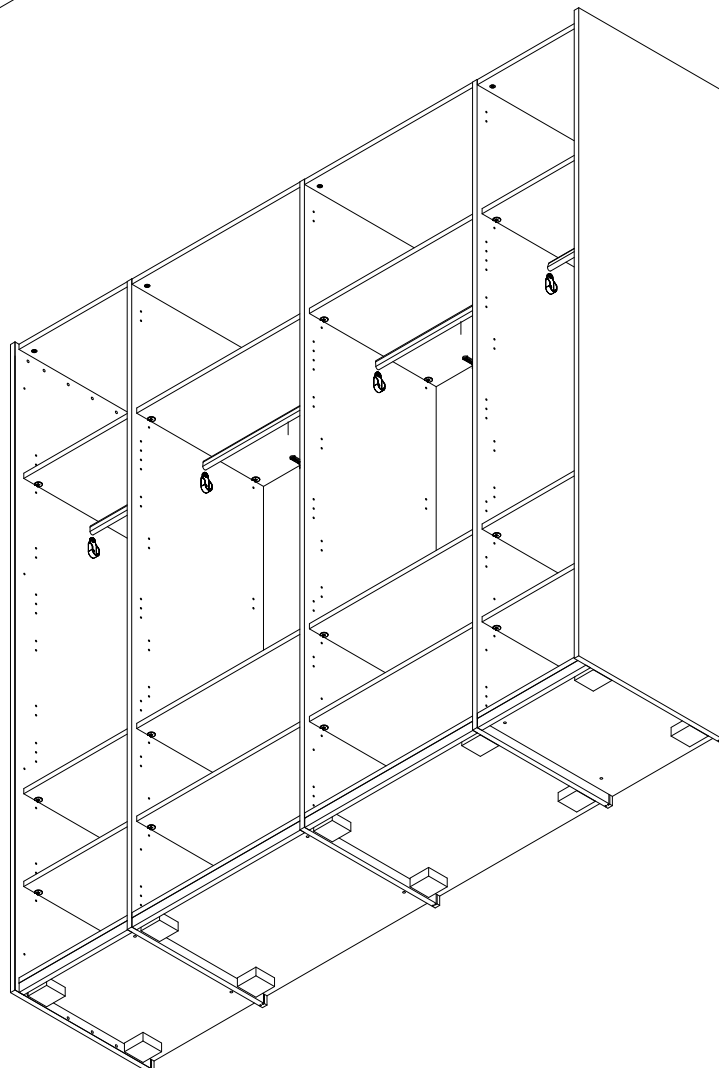
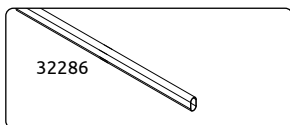
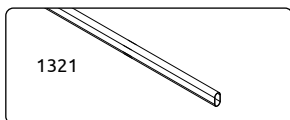

21

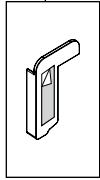
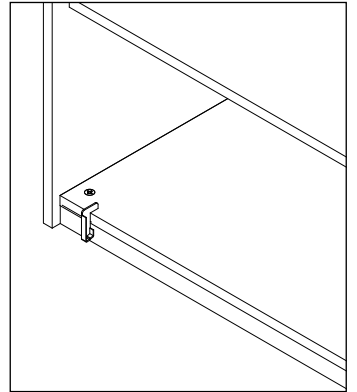
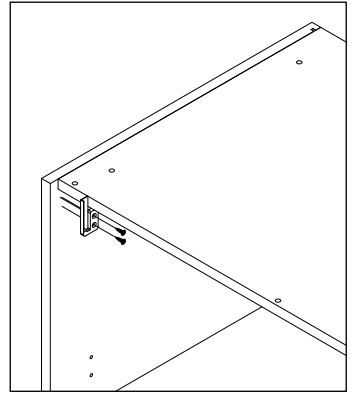
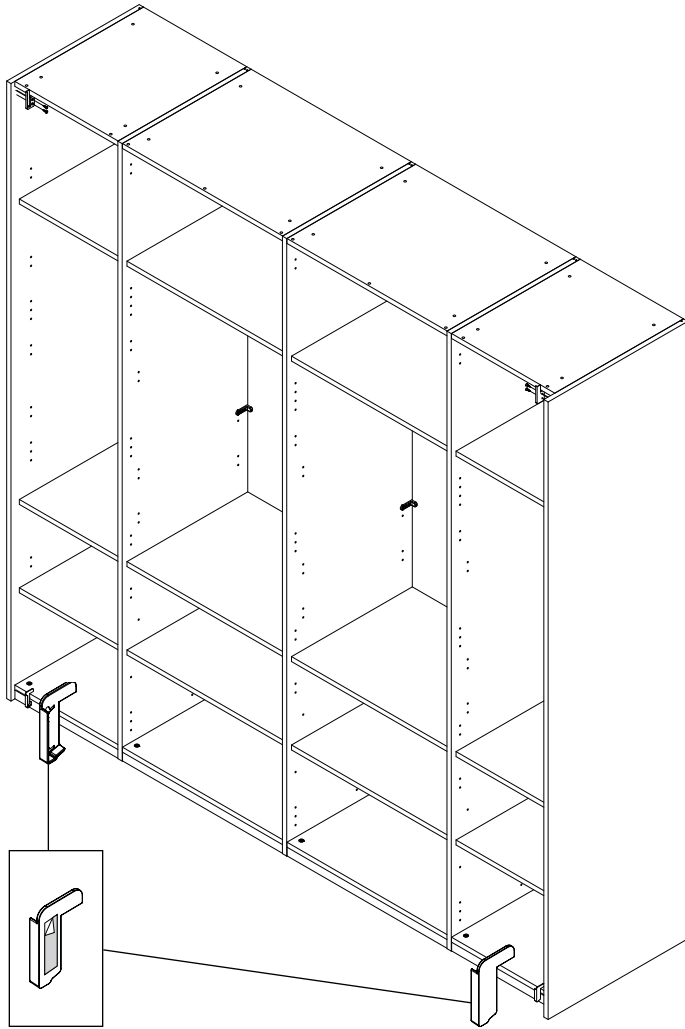
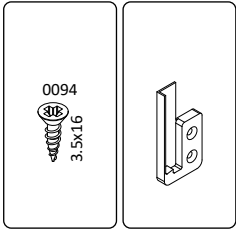

22

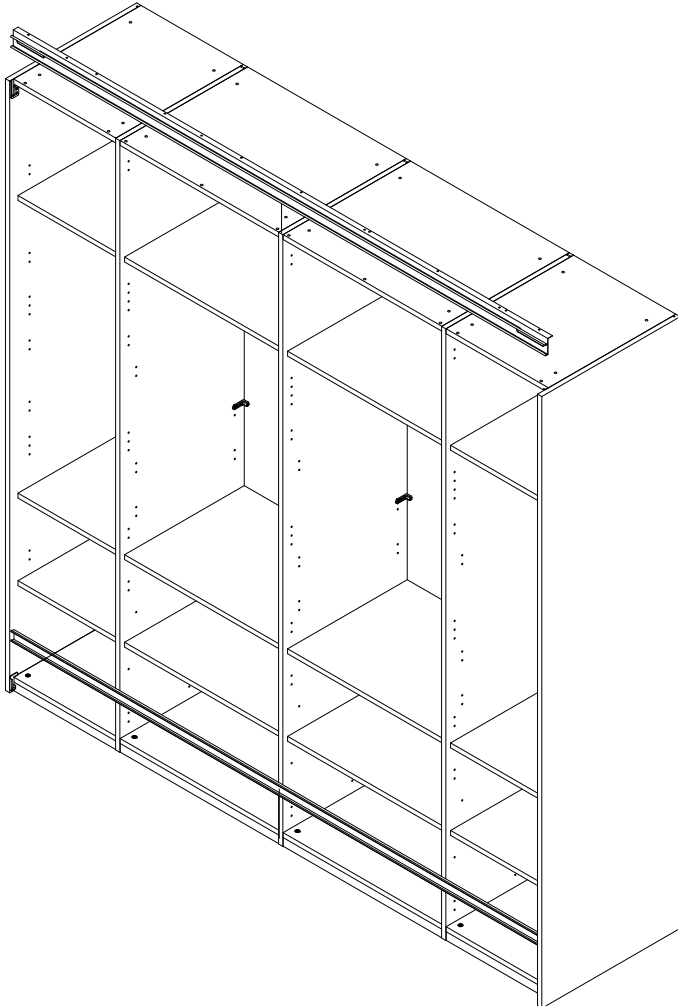
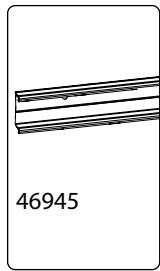
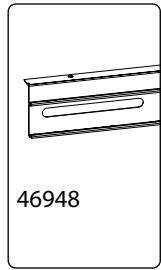

23

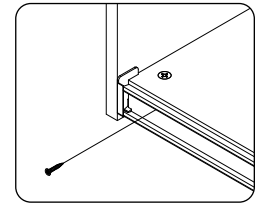
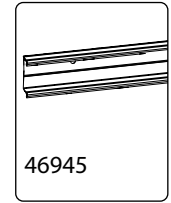
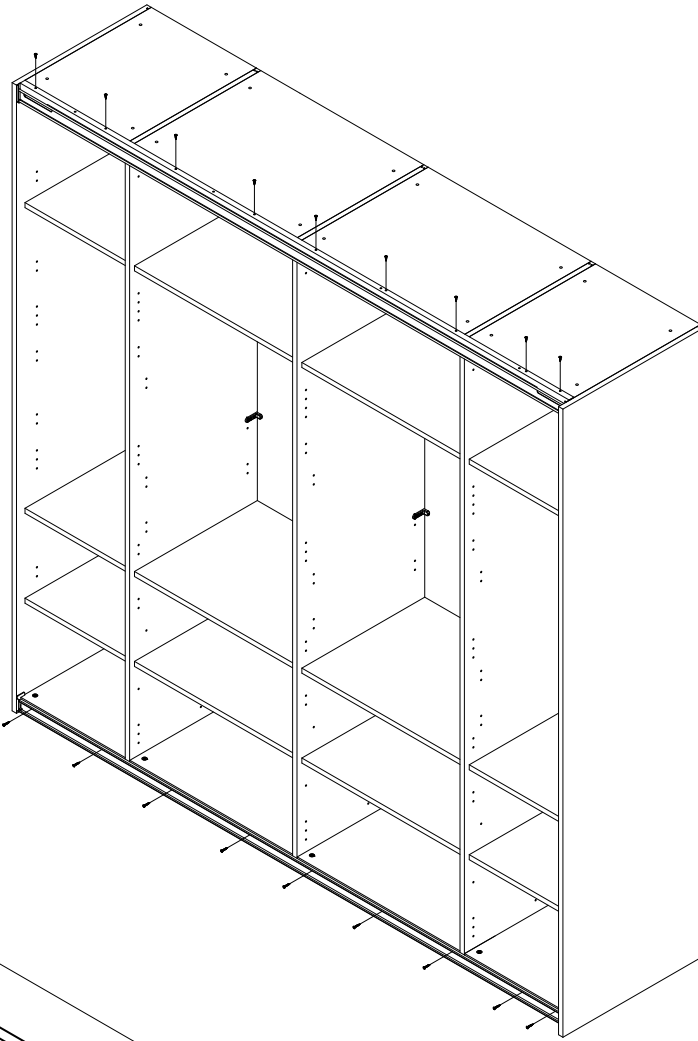
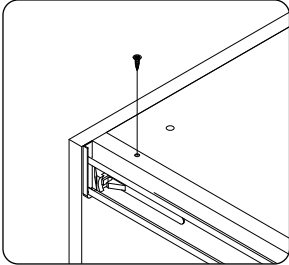
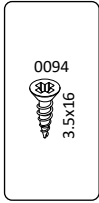
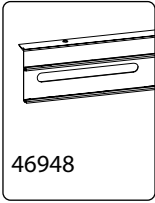

24

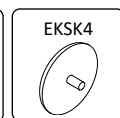
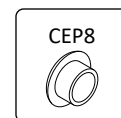
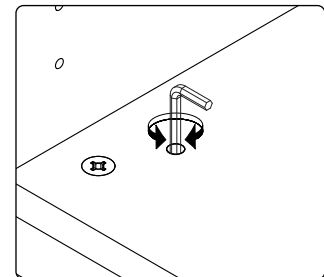
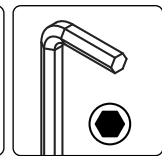
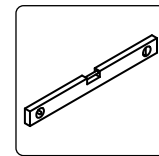
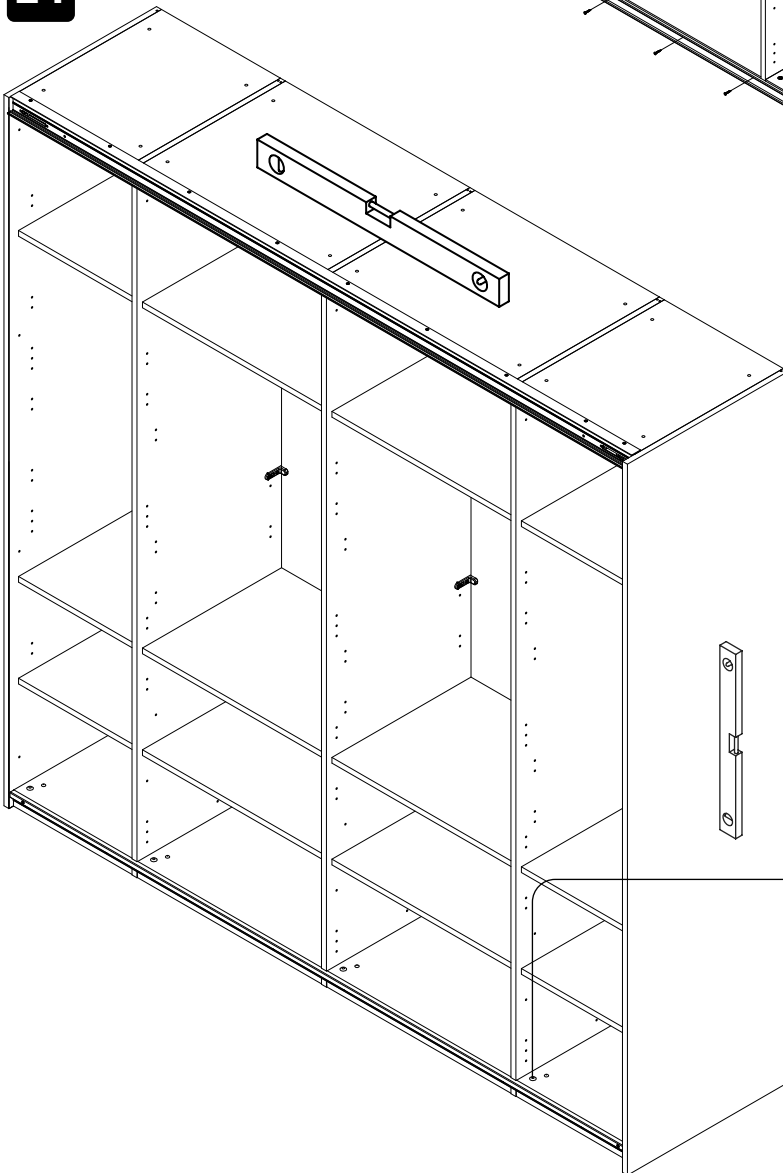

25

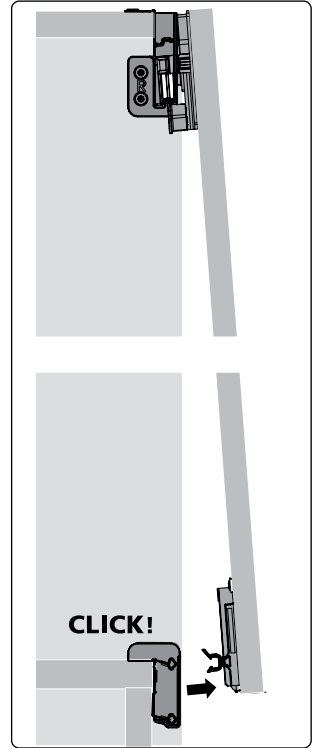
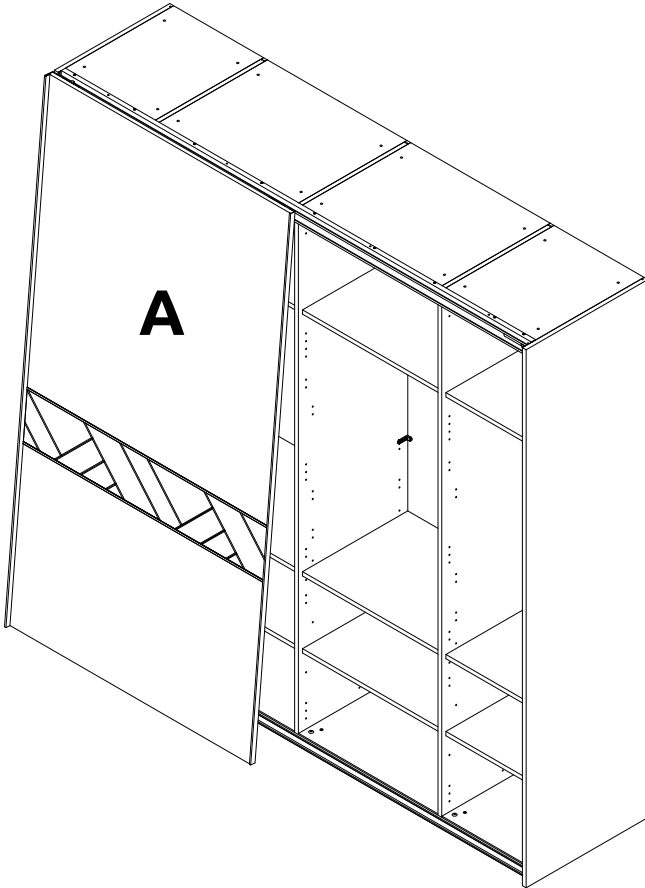
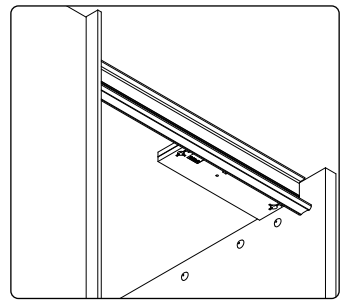
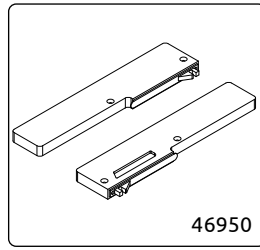
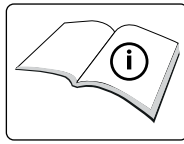

26

