

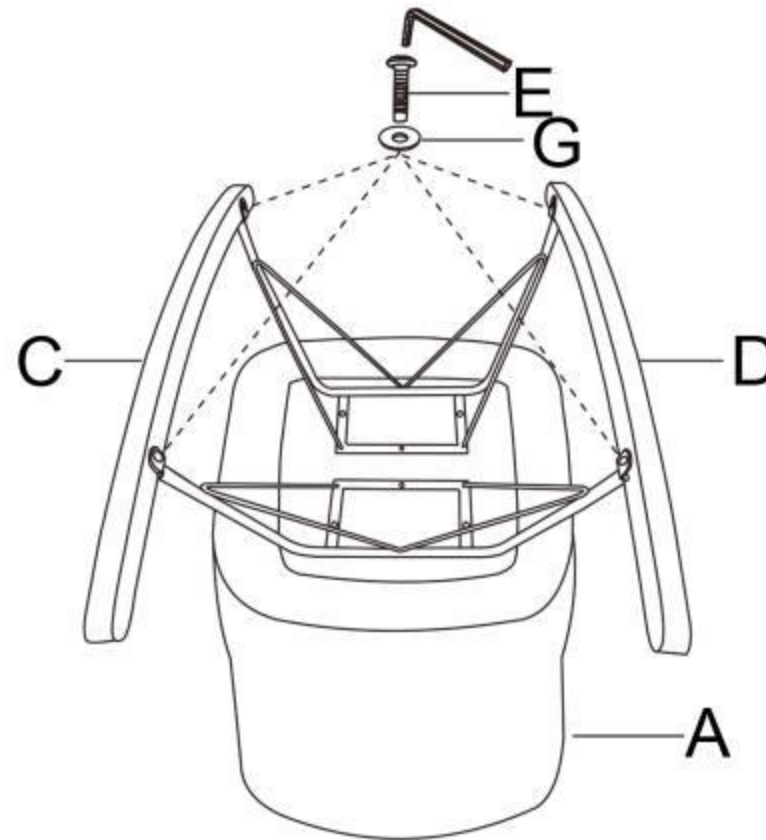

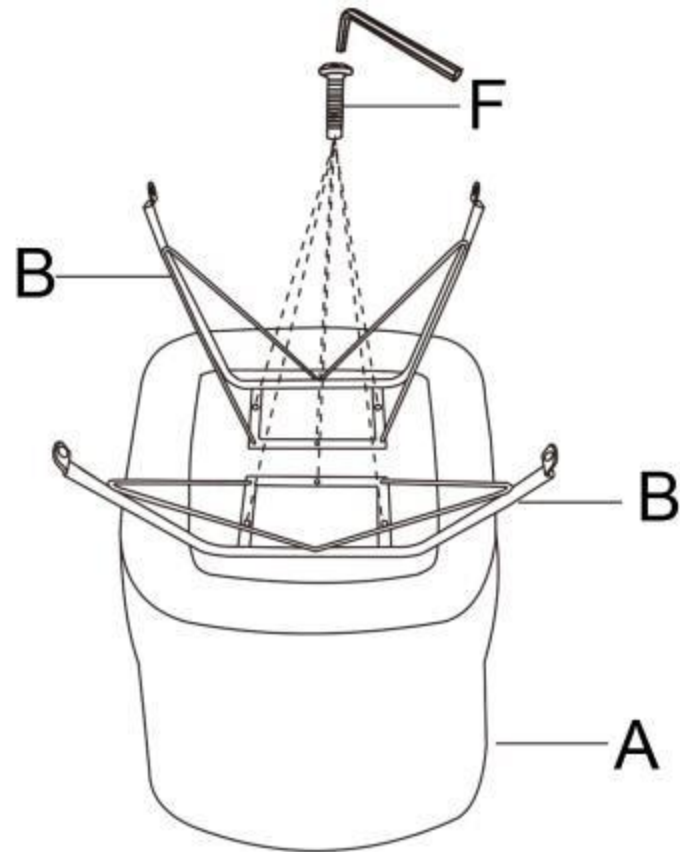





IMPORTANT – READ CAREFULLY – RETAIN FOR FUTURE REFERENCE

WICHTIG – SORGFÄLTIG LESEN UND AUFBEWAHREN

AUSTIN



A		1
B		2
C		1
D		1
E	 M6x20 mm	4
F	 M6x16 mm	6
G	 M6x16 mm	4



 max. 100 kg