















| NO | DESCRIPTION | QTY |
|----|------------------------------------------------------------------------------------------------------|--------|
| 1 | HEADBOARD  | 1 PC |
| 2 | FOOTBOARD  | 1 PC |
| 3 | SIDE RAIL  | 2 PCS |
| 4 | LVL SLATS  | 16 PCS |
| 5 | VERTICAL RAIL  | 1 PC |
| 6 | SIDE PLASTIC CAP  | 32 PCS |
| 7 | BED LEG  | 4 PCS |

| NO | DESCRIPTION | QTY |
|----|---------------------------------------------------------------------------------------------------------|-------|
| A | JCBB M8 X 40MM  | 8PCS |
| B | JCBC M6 X 50MM  | 2PCS |
| C | SPRING WASHER 5/16"  | 10PCS |
| D | FLAT WASHER 5/16"  | 8PCS |
| E | FLAT WASHER 1/4"  | 2PCS |
| F | ALLEN KEY M4  | 1PC |
| G | ALLEN KEY M5  | 1PC |

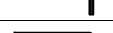

3

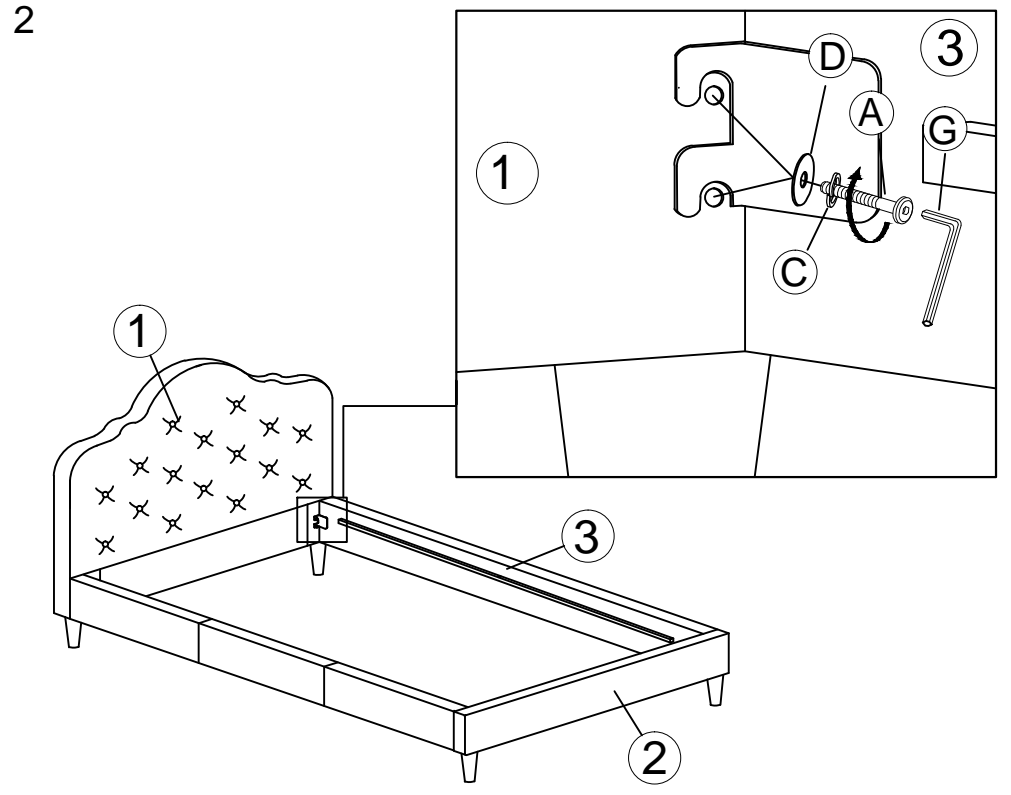
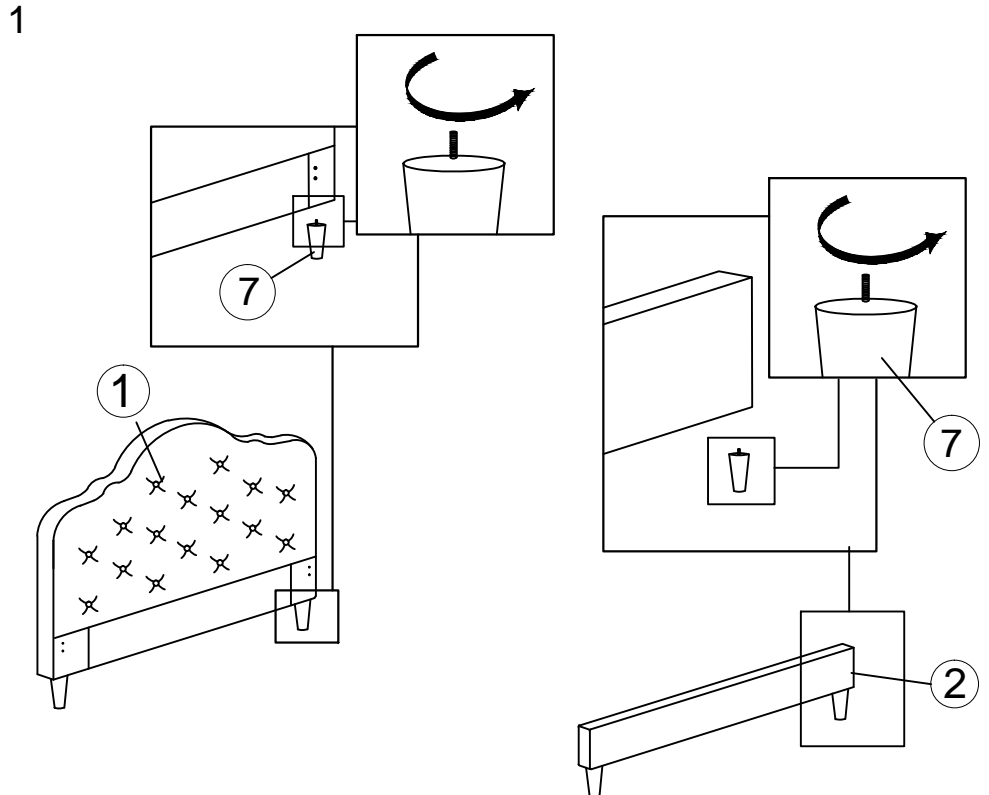
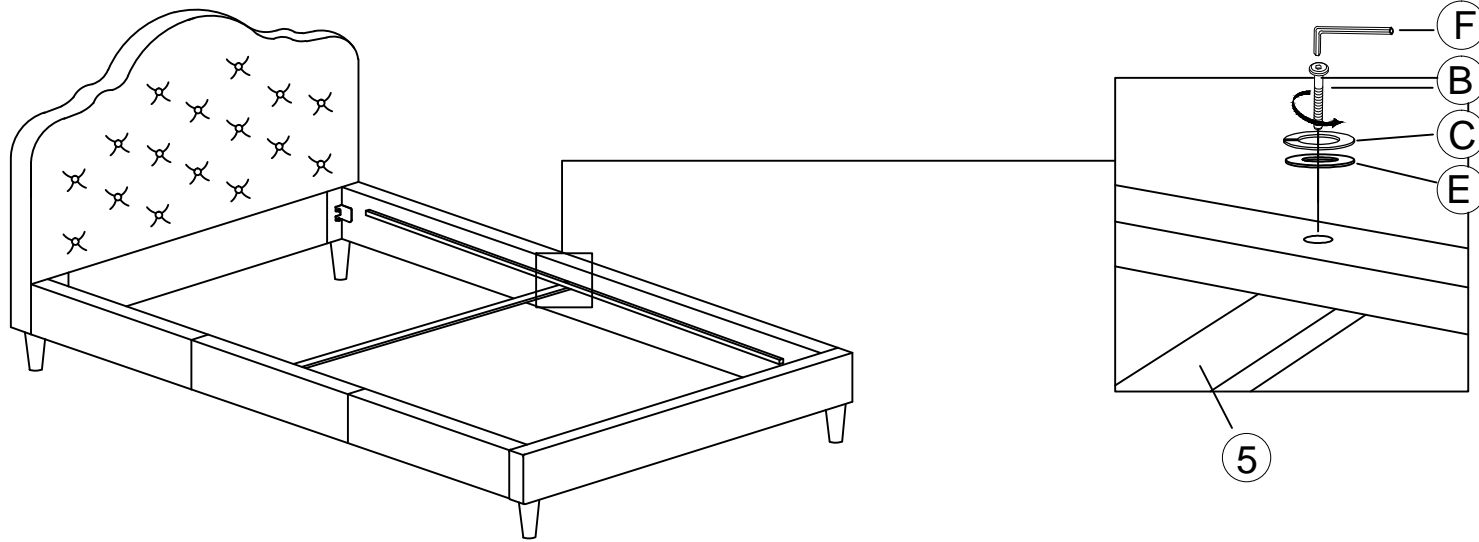

4

