

20.72.1706.00

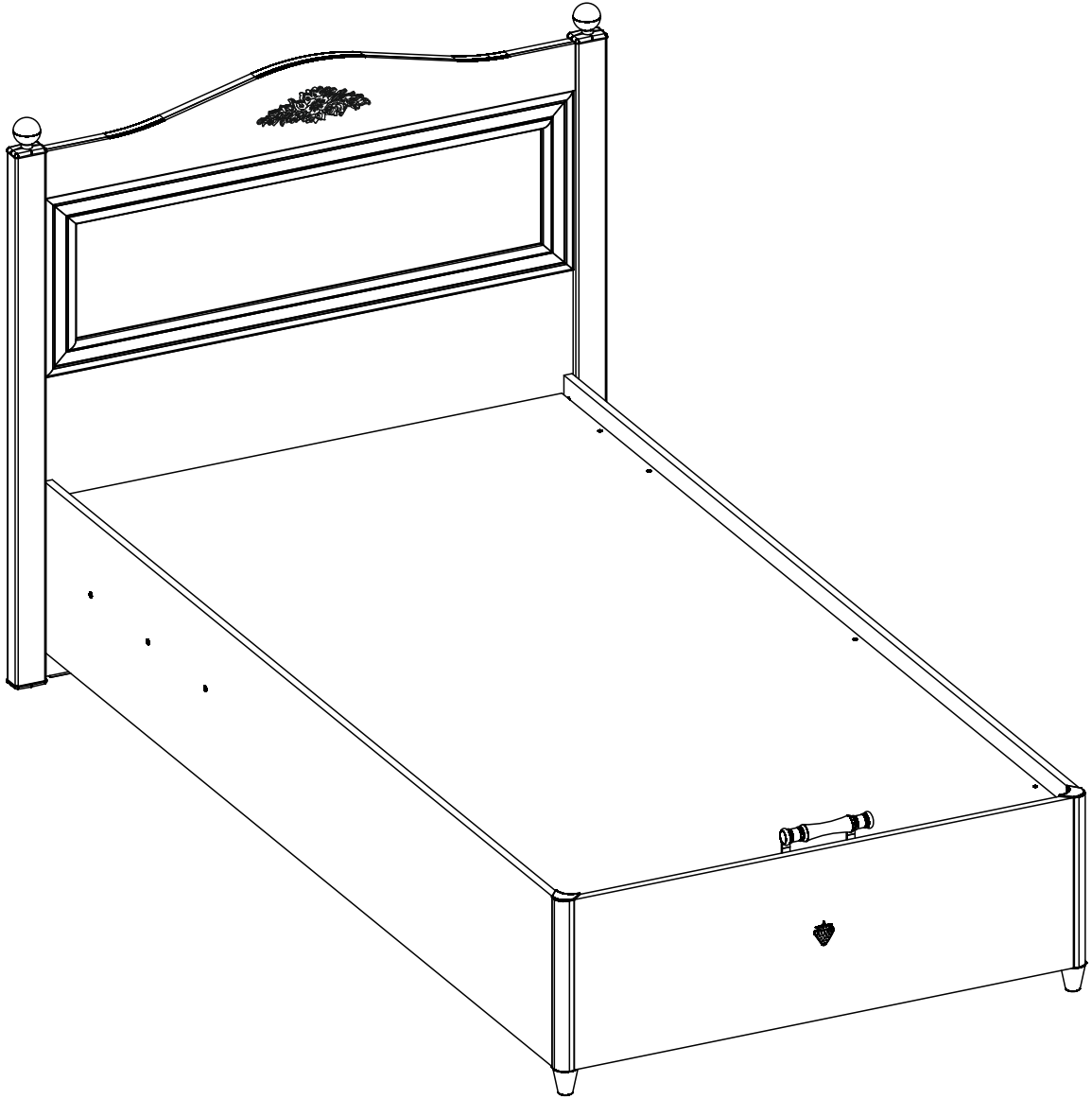

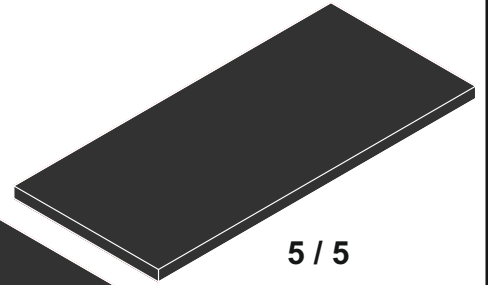

13.07.01.093 x 12

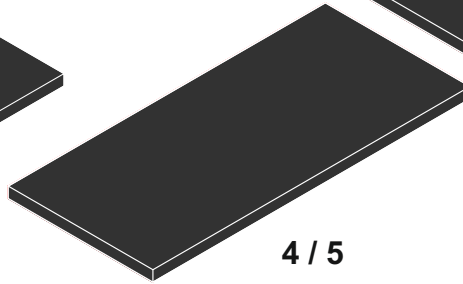
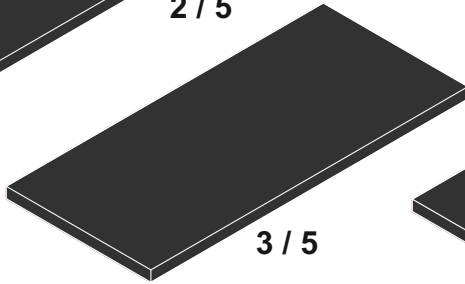
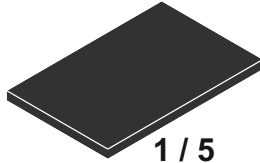
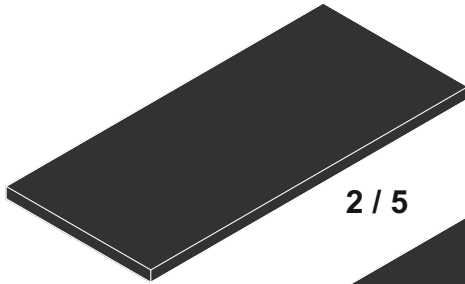
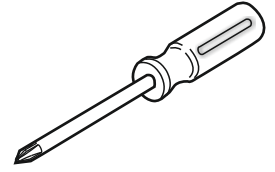
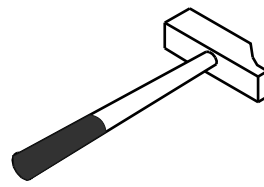
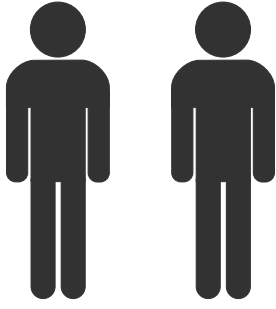

13.02.01.017 x 38

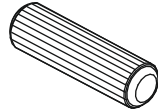

13.01.01.111 x 8

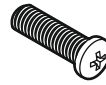

M6X20
13.03.01.026 x 6

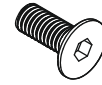

M6X15
13.03.01.024 x 6

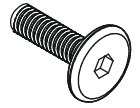

13.03.01.023 x 2

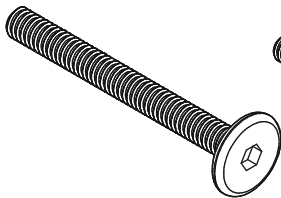

M6X55
13.03.01.039 x 4

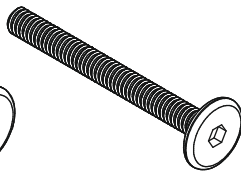

M6X40
13.03.01.035 x 10



M4X40
13.03.01.117 x 2

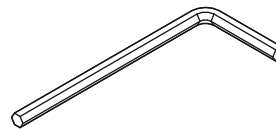

13.07.01.016 x 1

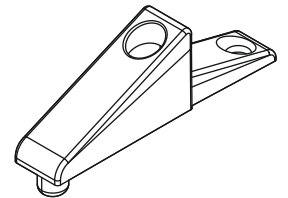

13.01.01.247 x 6

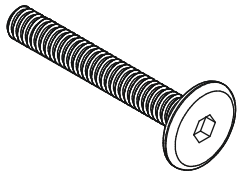

M6X35
13.03.01.033 x 2



13.01.01.045 x 6

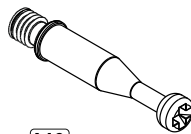

M6
13.07.01.108 x 6



13.07.01.110 x 6

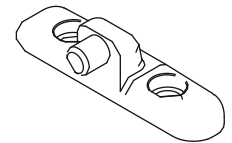

13.01.01.248 x 10

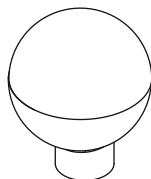

M6X35
13.01.01.723 x 2

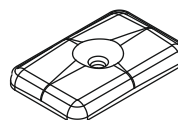

13.01.01.724 x 2

1 / 5

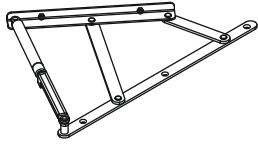

13.07.01.576 x 1

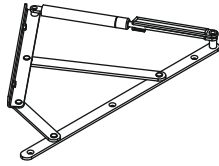

13.07.01.577 x 1

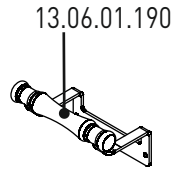

13.06.01.190
18.72.1706.204 x 1

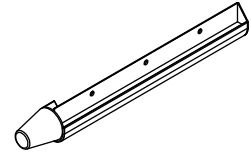

18.72.1706.203 x 2

2 / 5

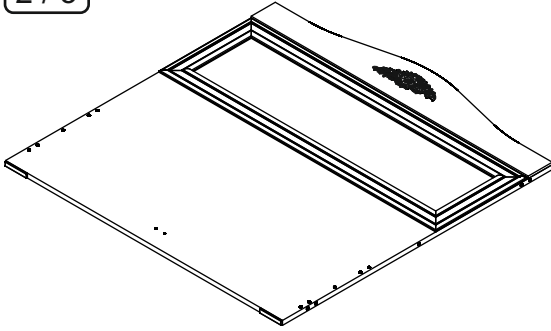

18.72.1706.004 x 1

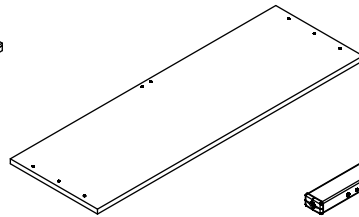

18.72.1706.003 x 1

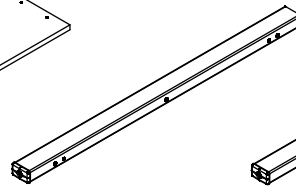

18.72.1706.007 x 1

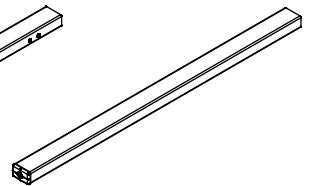

18.72.1706.008 x 1

3 / 5

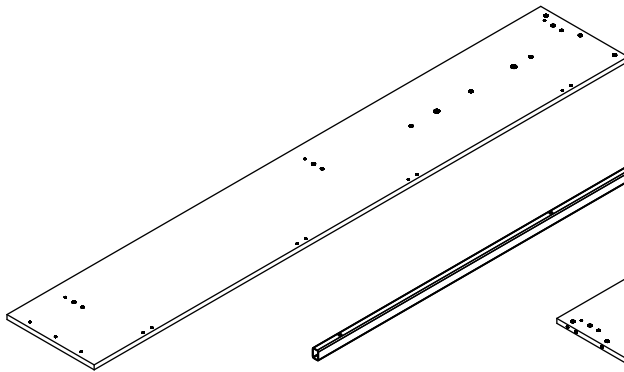

18.72.1706.001 x 1

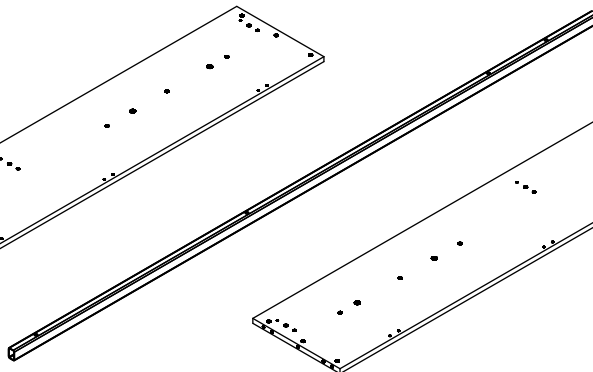

18.72.1706.201 x 2

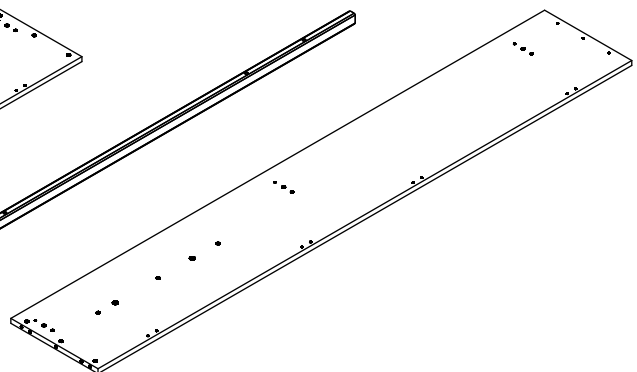

18.72.1706.002 x 1

4 / 5

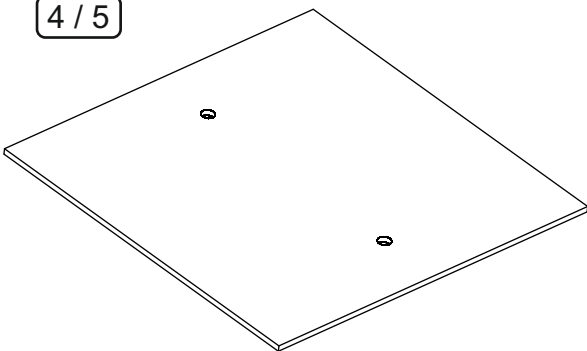

18.72.1706.006 x 2

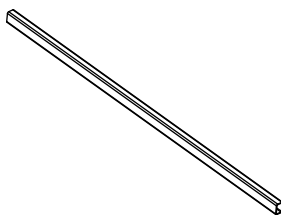

18.72.1706.202 x 1

5 / 5

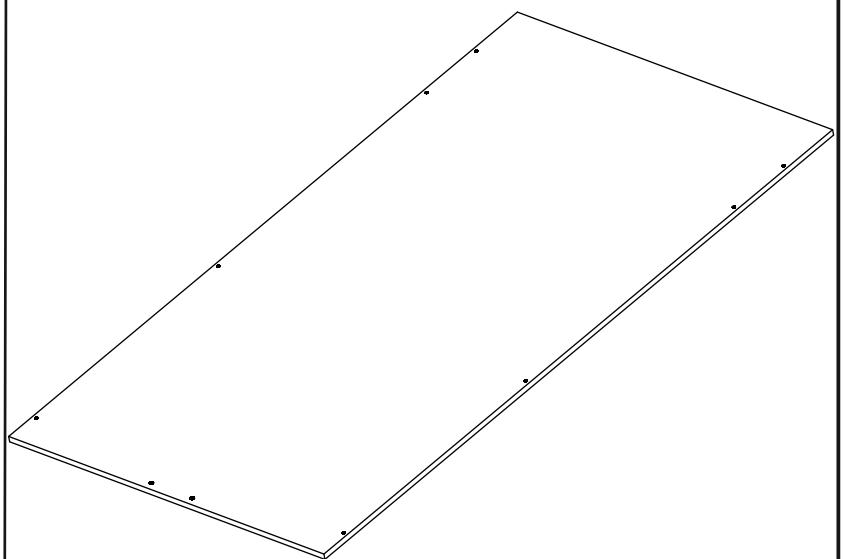

18.72.1706.005 x 1

1

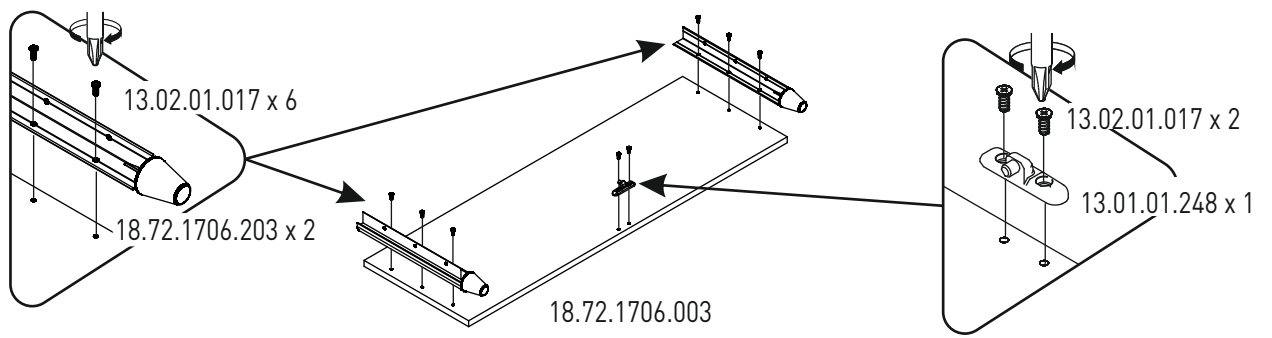

2

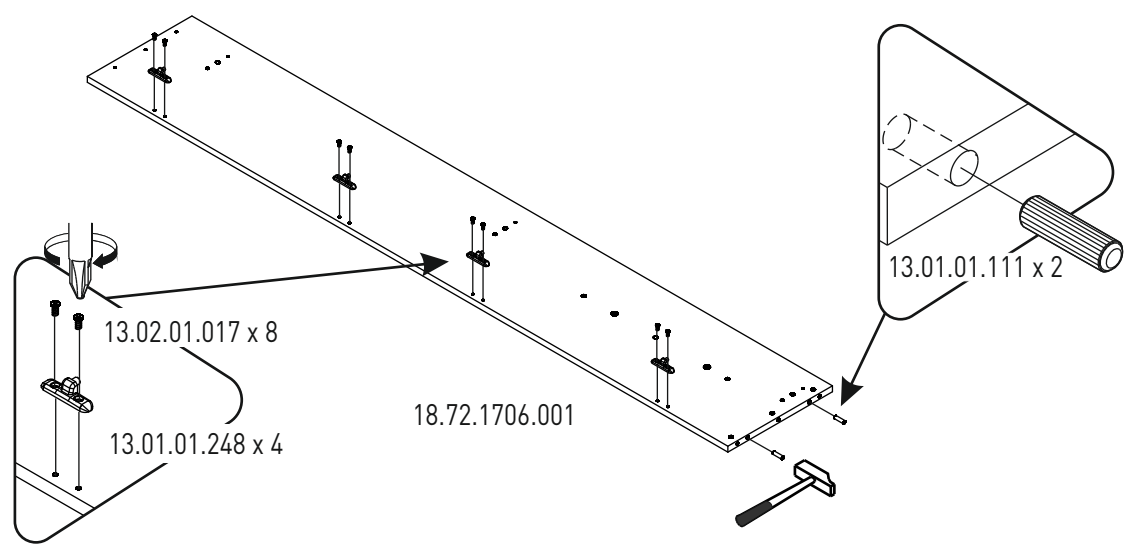

3

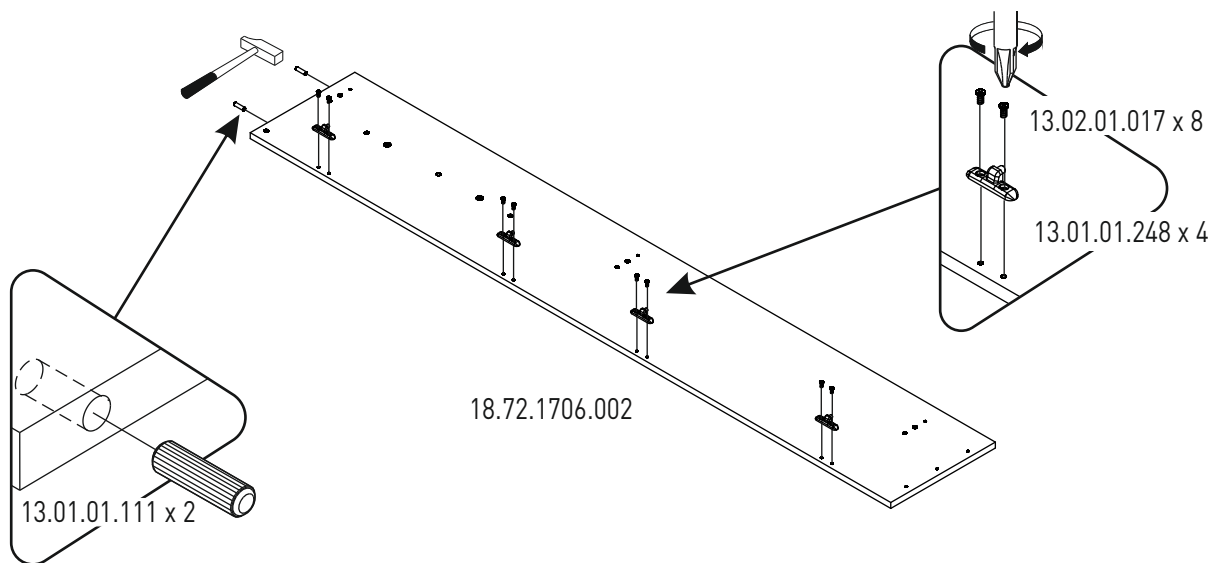

4

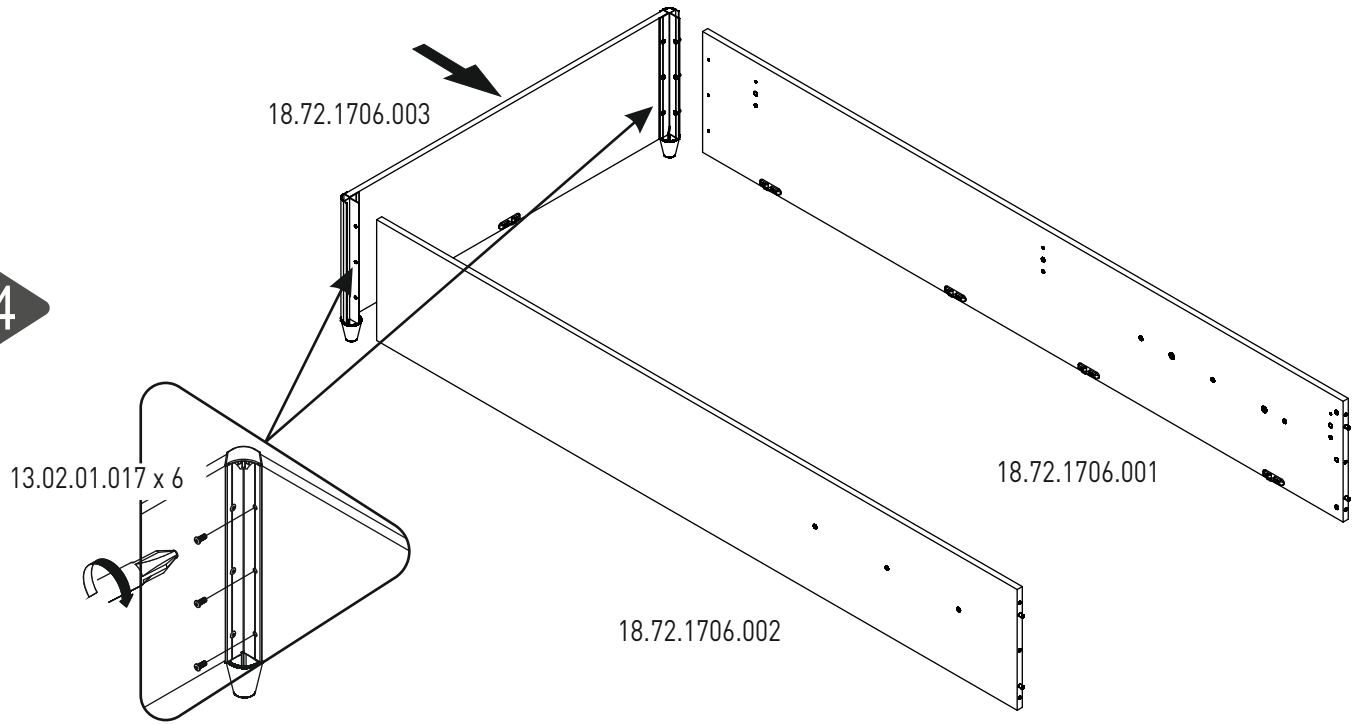

5

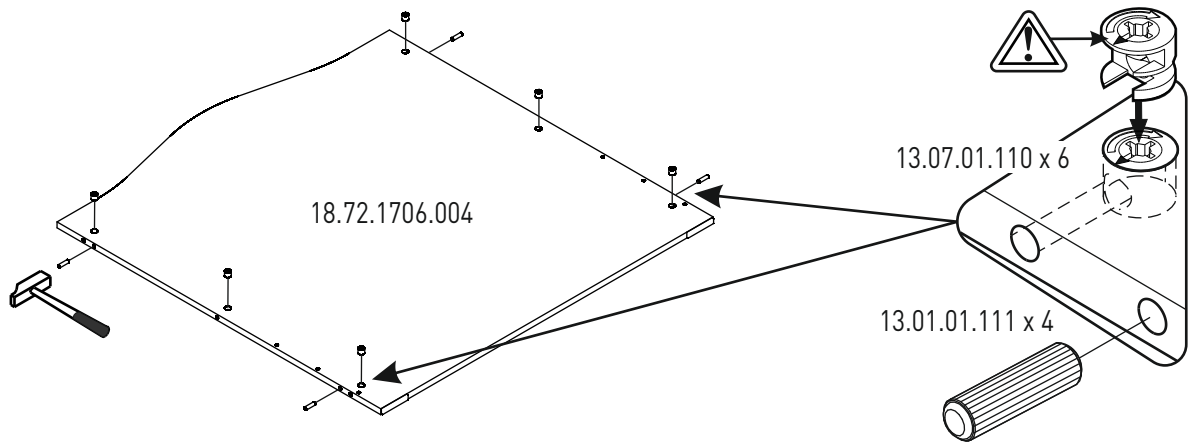

6

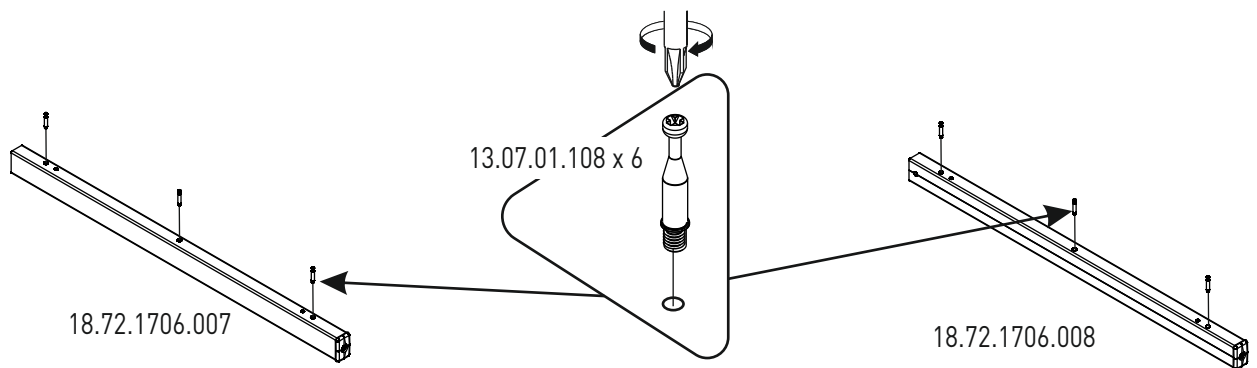

7

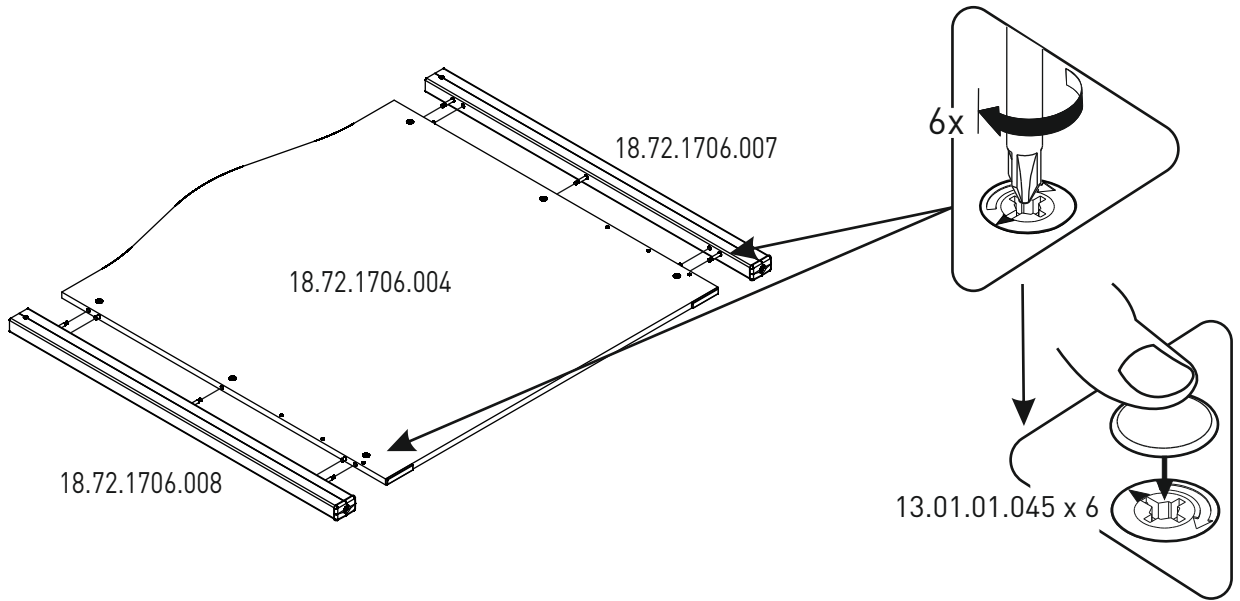

8

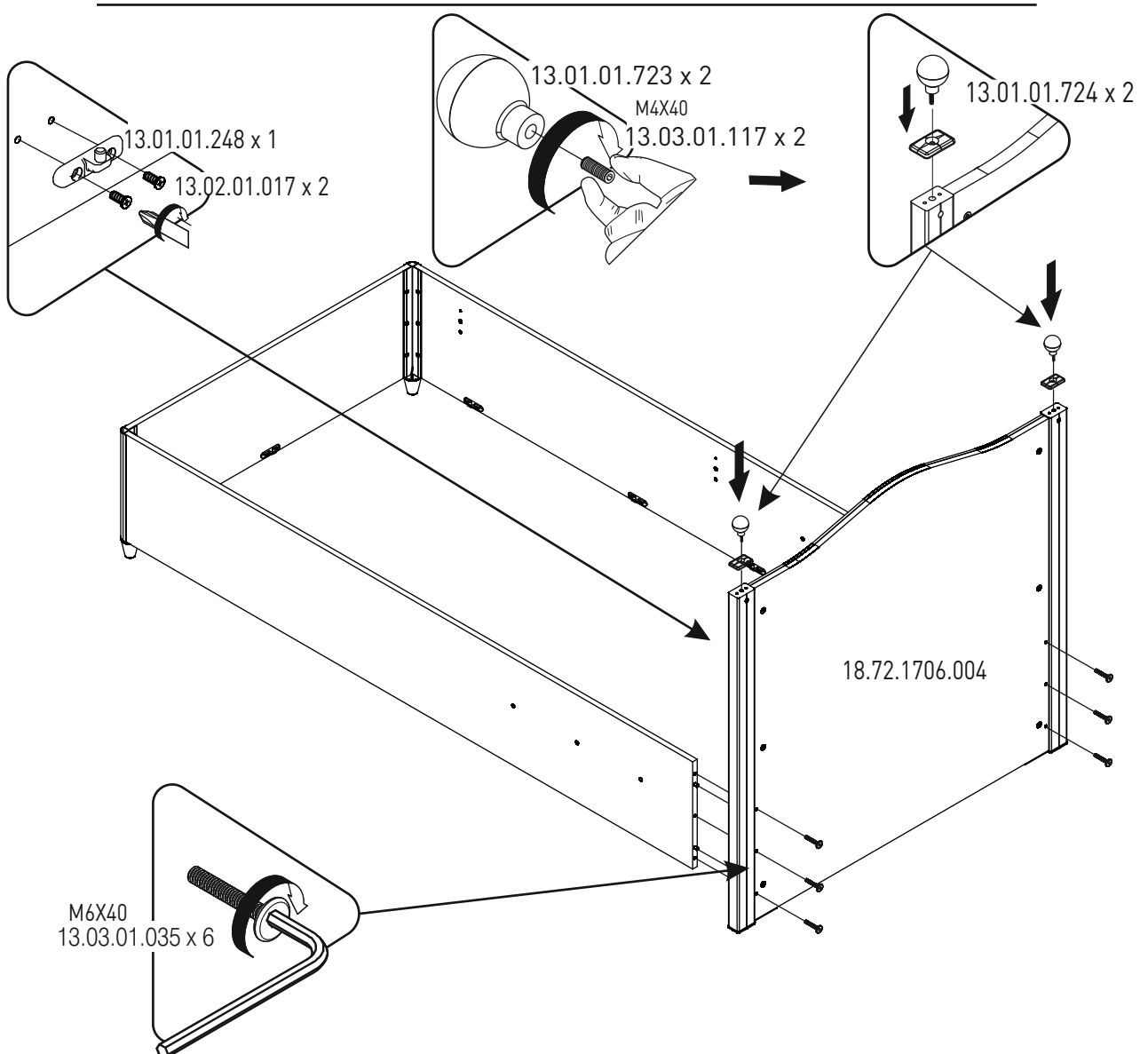

9

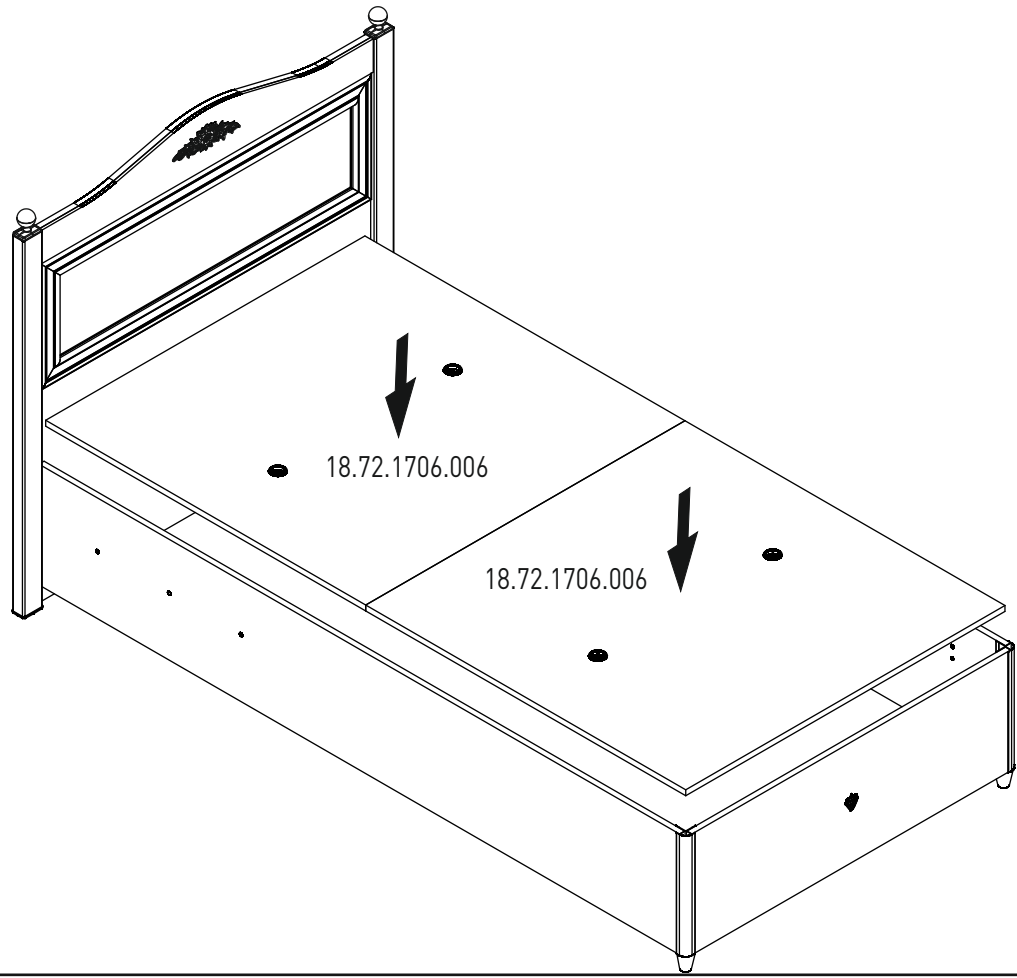

10

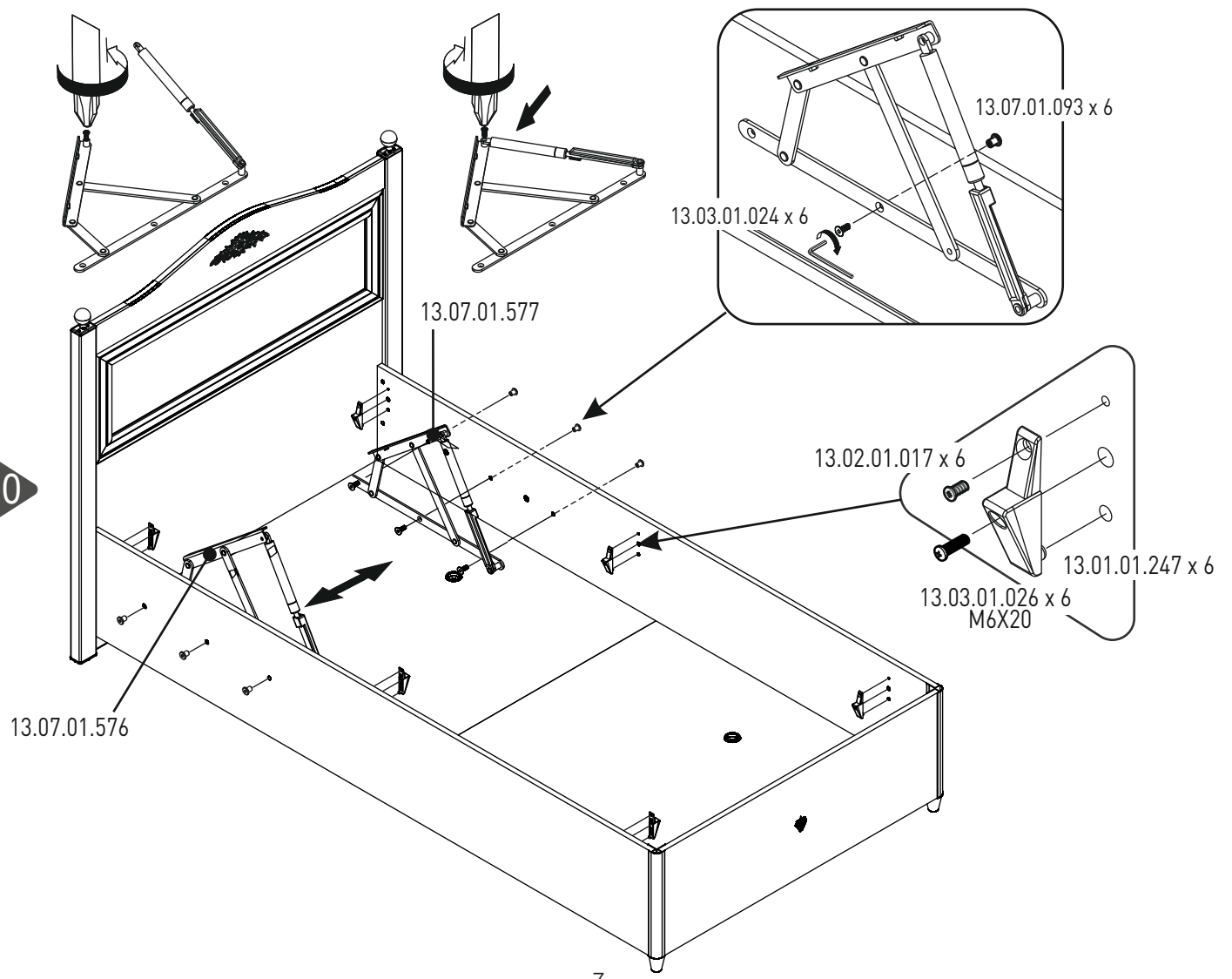

11

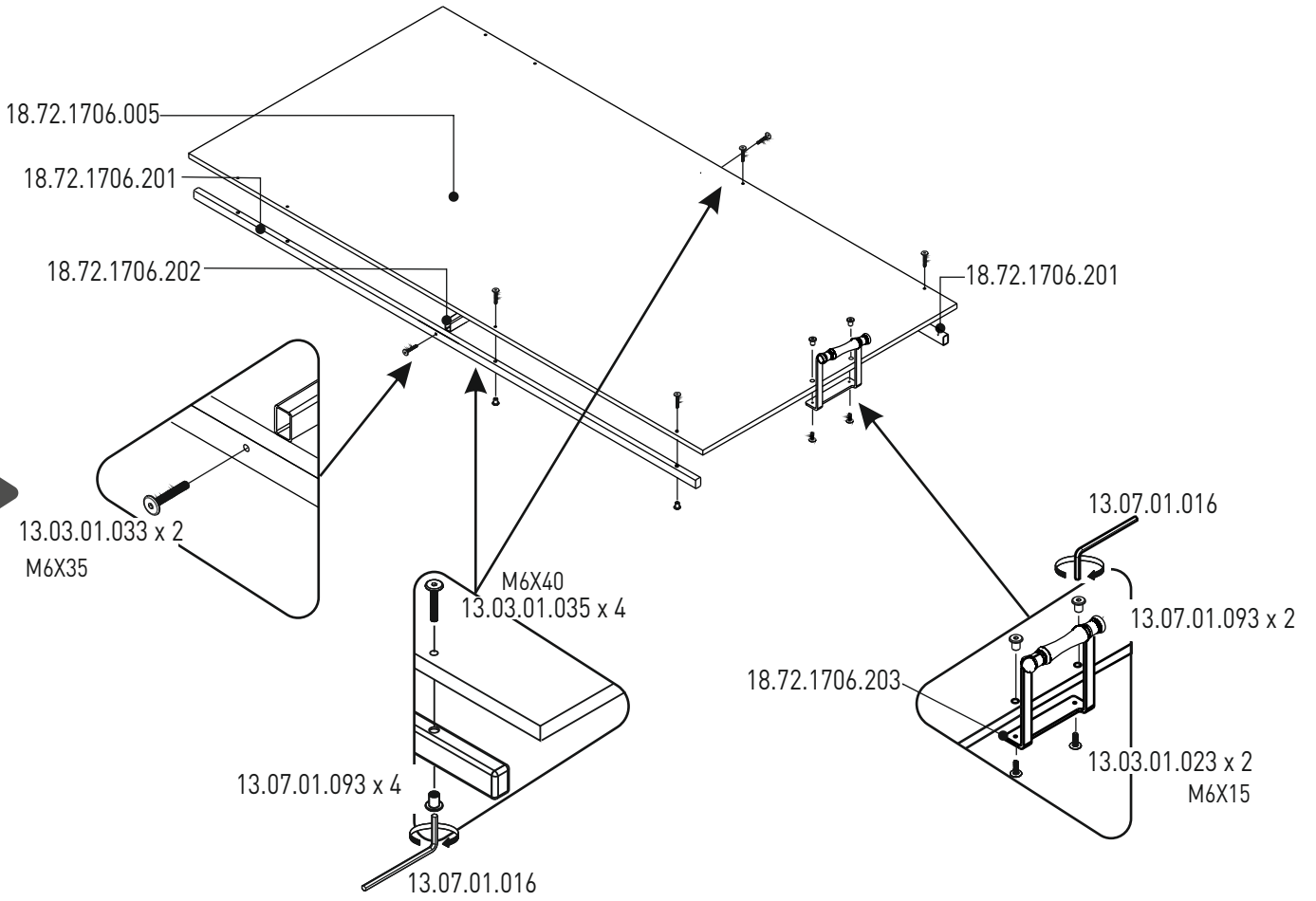

12

