

300er

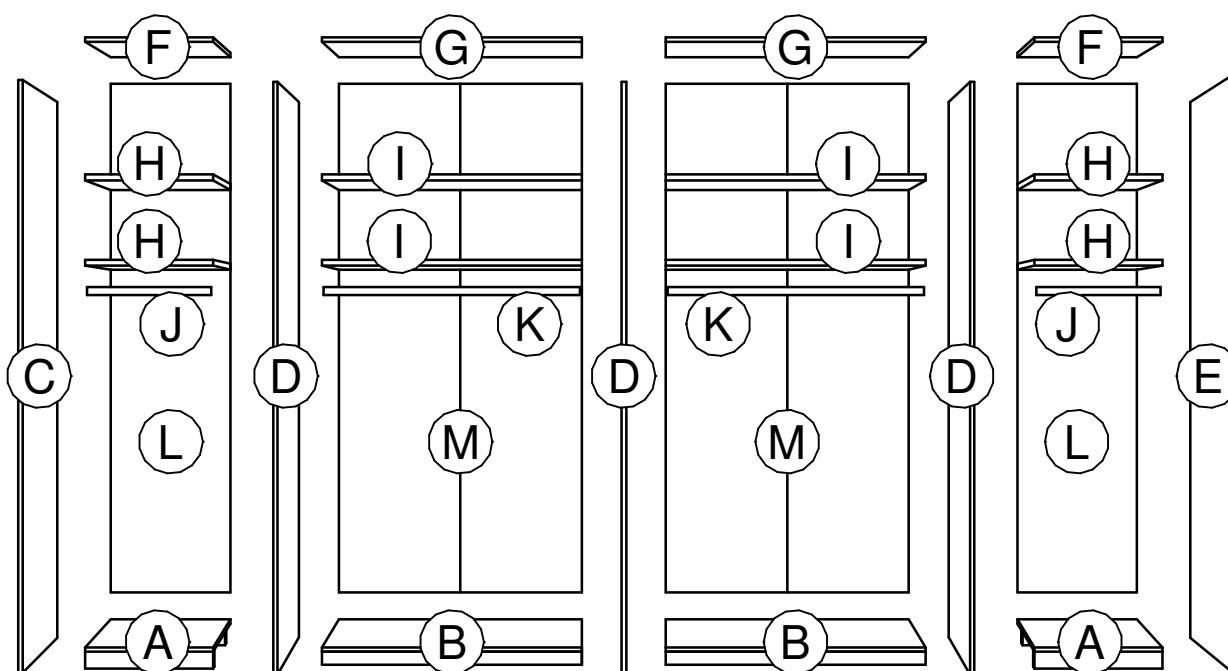

260er

480	784	784	480
-----	-----	-----	-----

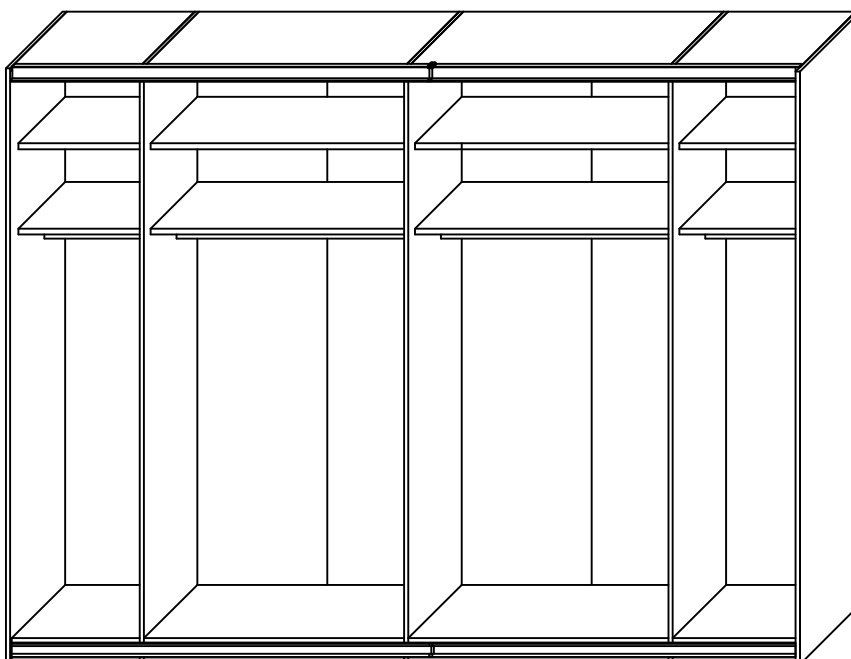

280er

576	784	784	576
-----	-----	-----	-----

880	976	880
-----	-----	-----

300er

480	976	976	480
-----	-----	-----	-----

976	976	976
-----	-----	-----

320er

576	976	976	576
-----	-----	-----	-----

976	1168	976
-----	------	-----

340er

480	1168	1168	480
-----	------	------	-----

1168	976	1168
------	-----	------

1.

660.4671.000

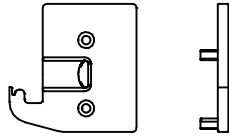

①

1 x

632.0038.000

4 x 14 mm



②

2 x

641.0227.000

12 mm



③

4 x

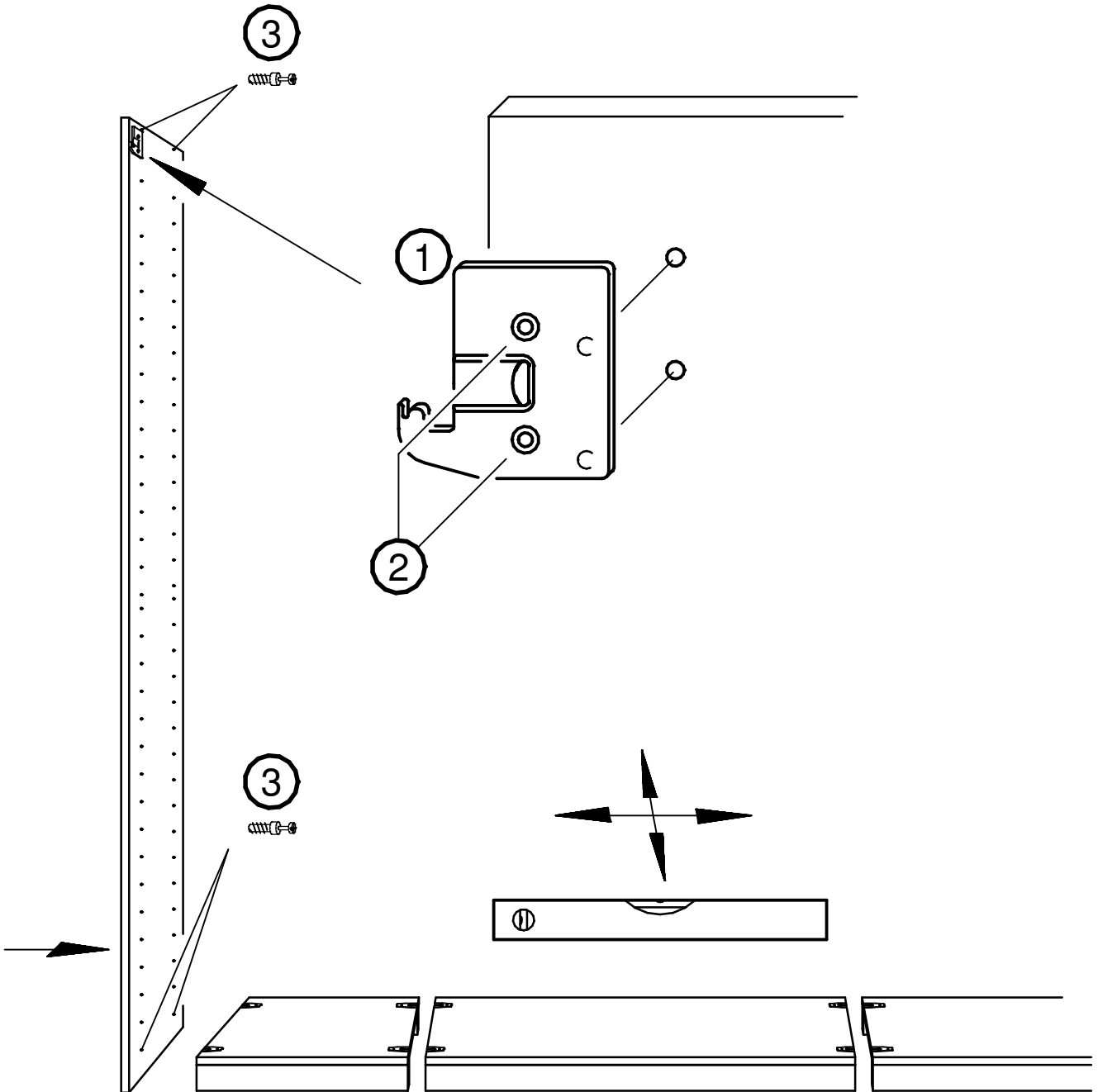

2.

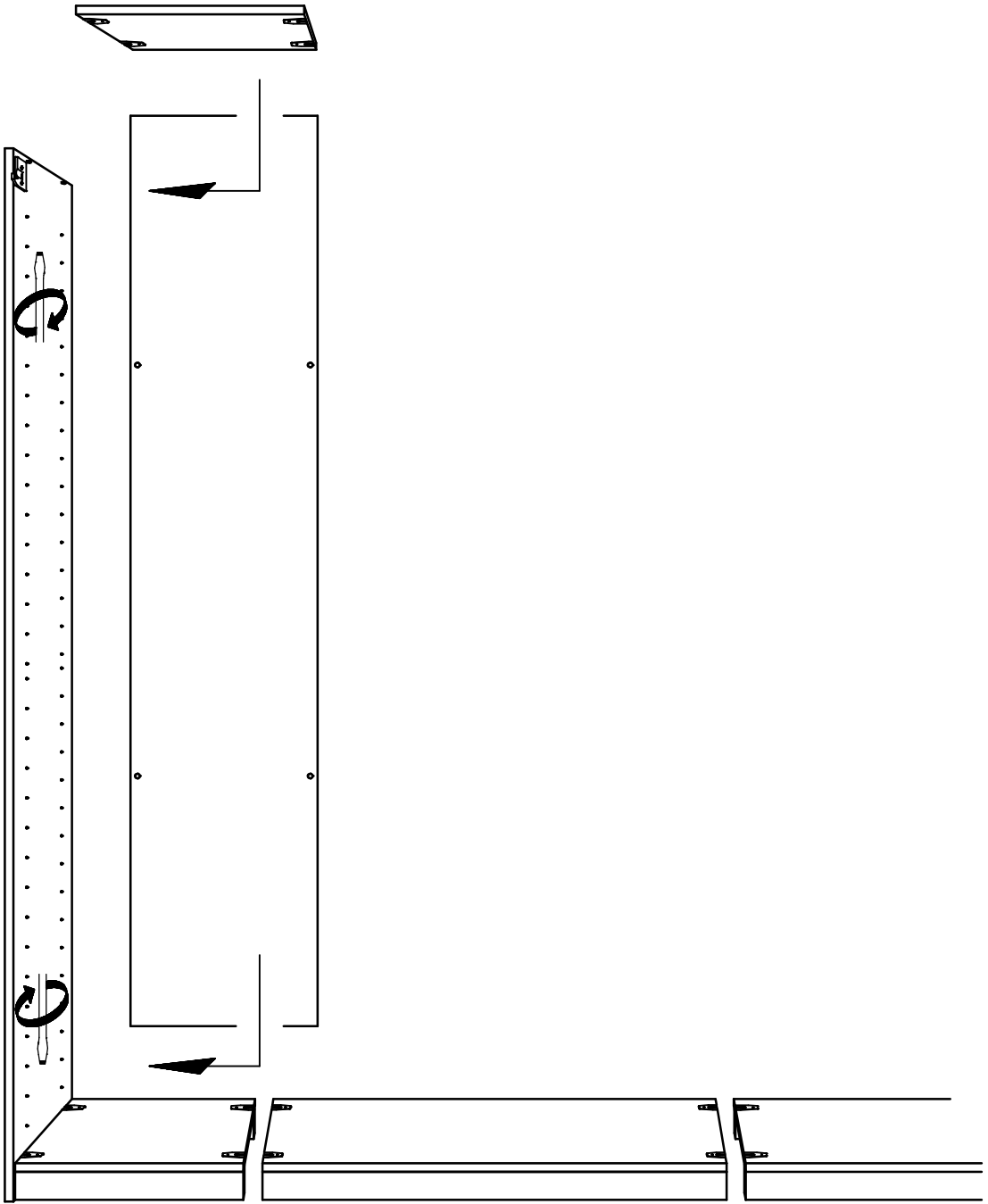

621.2930.000

631.1266.000

6,3 x 11 mm

631.1472.000

3,5 x 15 mm

641.0226.000

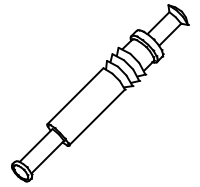
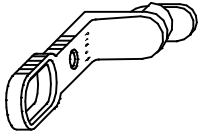

④

⑤

⑥

⑦

3.

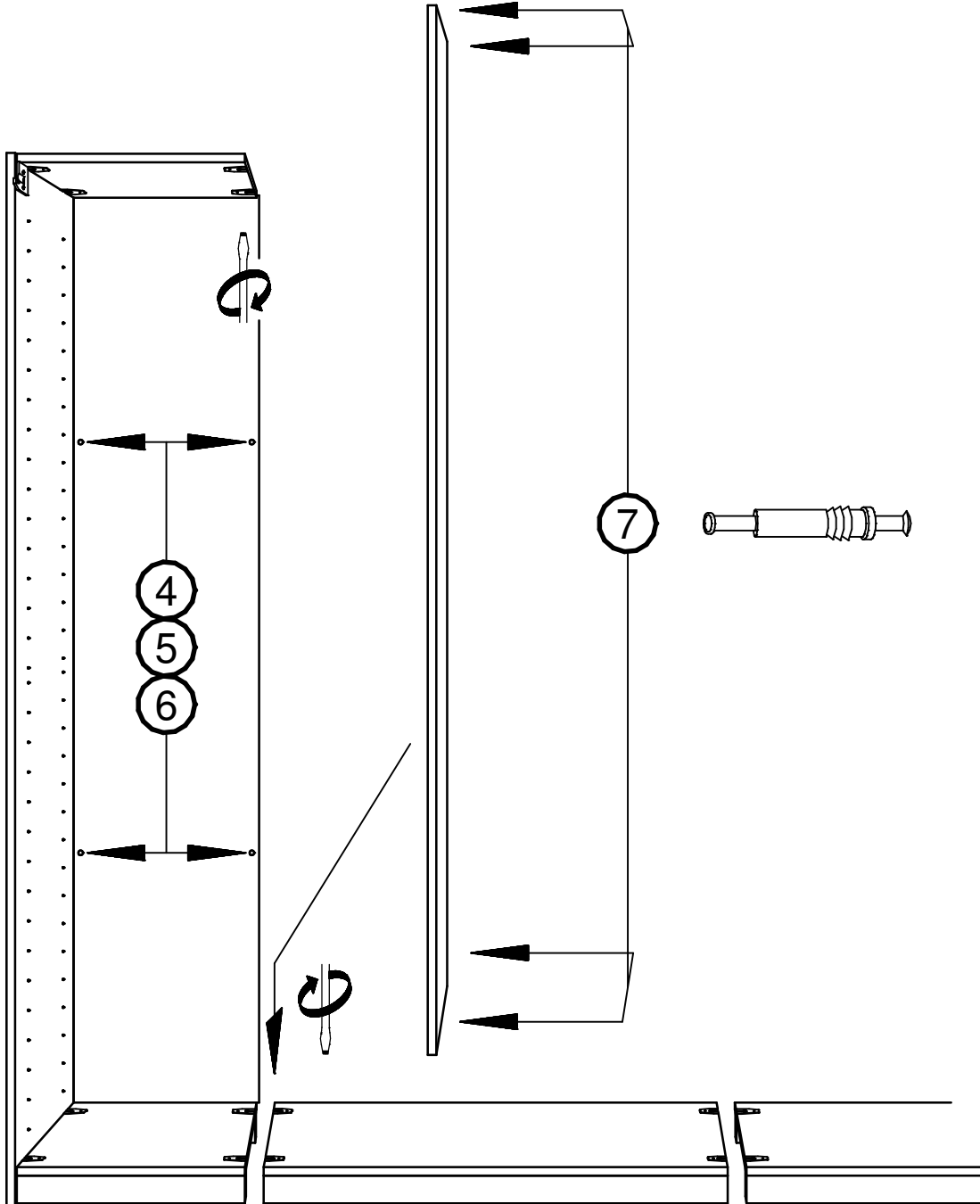

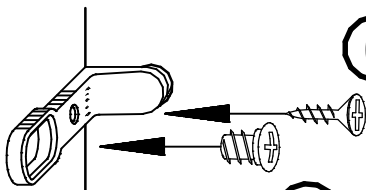

④

⑥

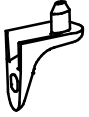

⑤

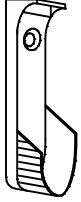
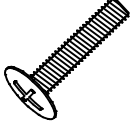
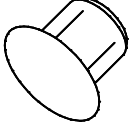
<p>641.0204.000</p>  <p>⑧</p>	<p>632.0038.000 4 x 14 mm</p>  <p>②</p>	<p>631.1472.000 3,5 x 15 mm</p>  <p>⑥</p>	<p>621.0067.000</p>  <p>⑨</p>
<p>4.</p>	<p>632.0517.000 M6 x 30 mm</p>  <p>⑩</p>		 <p>⑪</p>

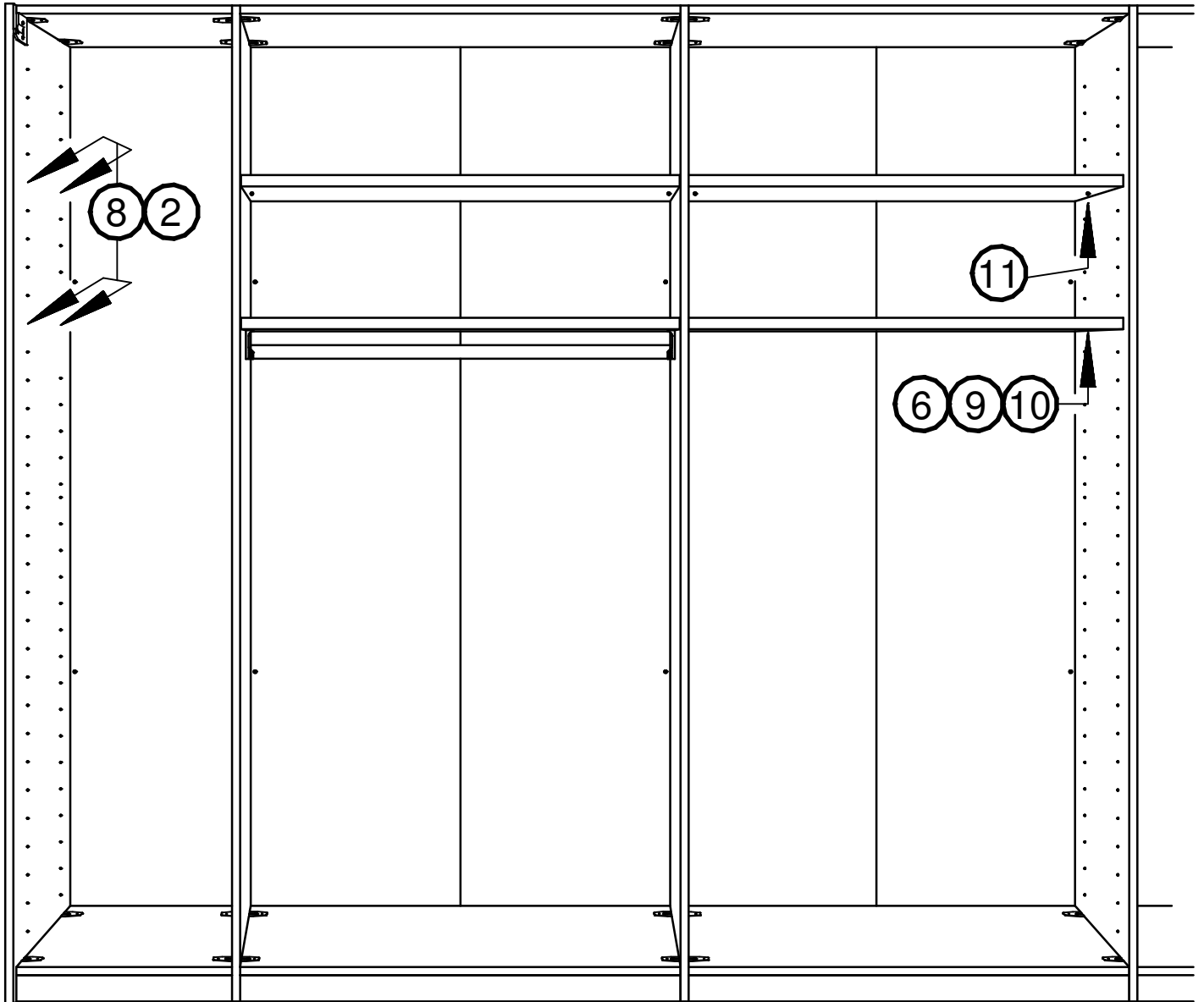

660.4670.000

632.0038.000

641.0227.000

4 x 14 mm

12 mm

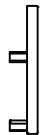
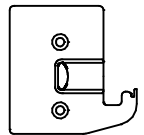

⑫

1 x

②

2 x

③

4 x

5.

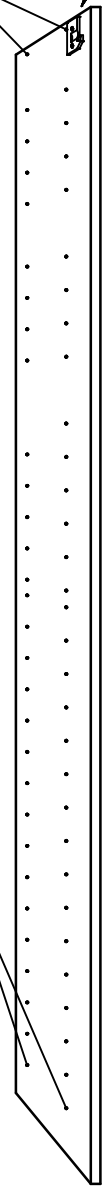
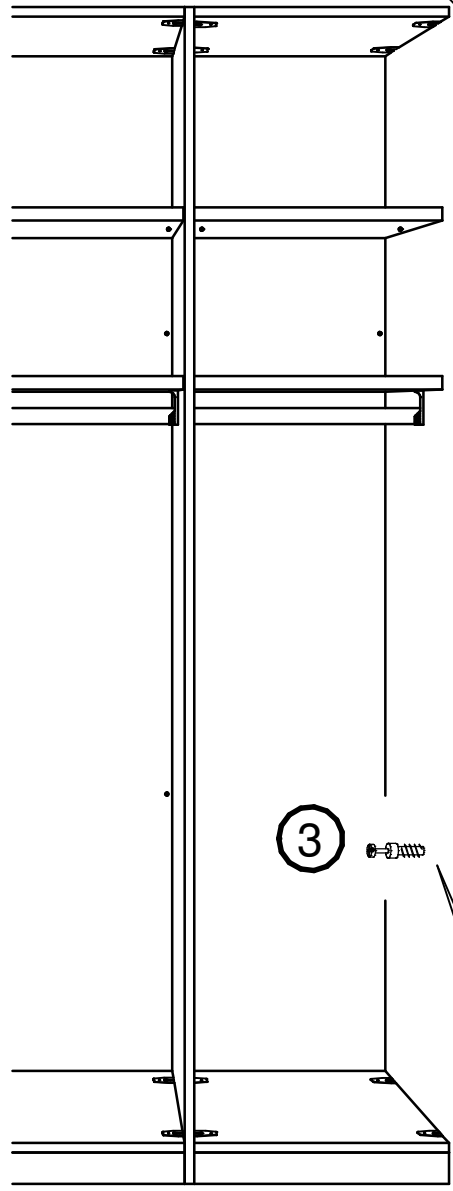
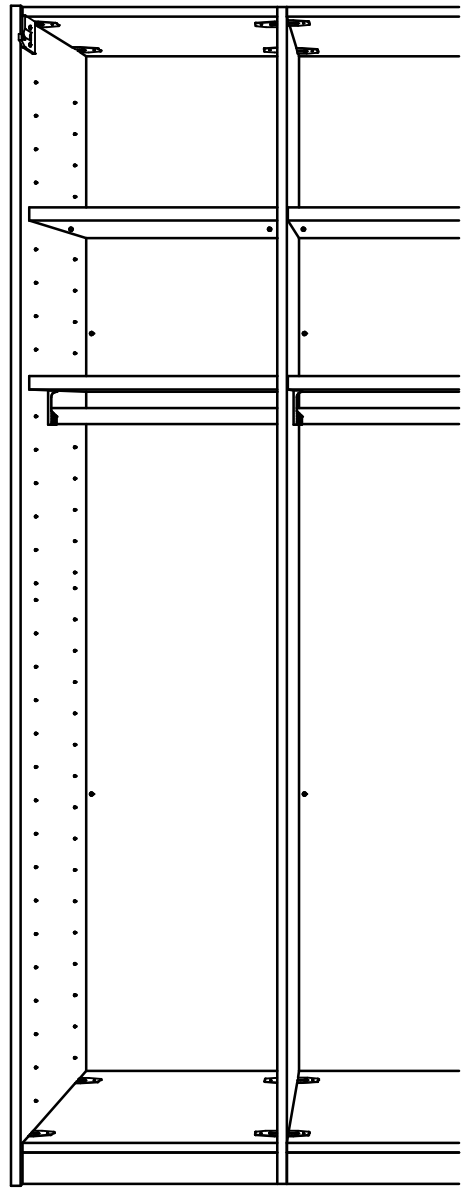
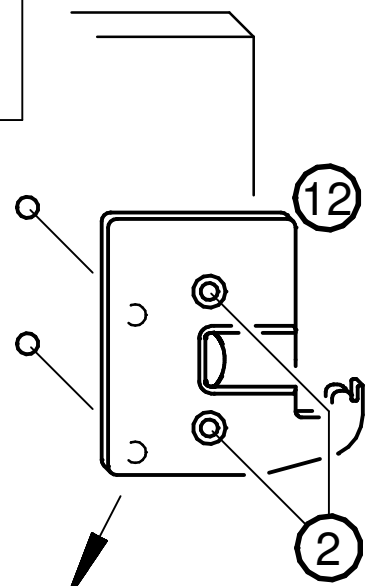

660.4676.000



13

660.4677.000

M4x12



14

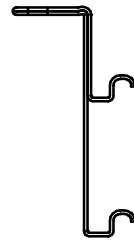

15

660.4668.000

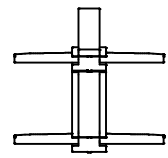

16

1 x

1 x

6.

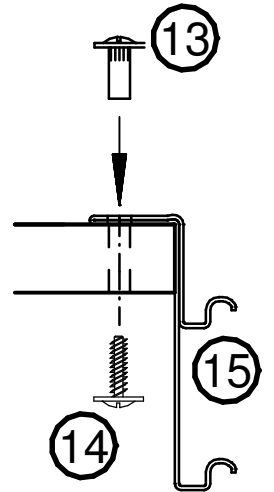
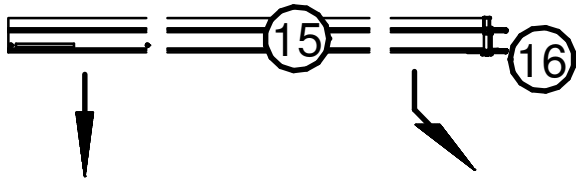
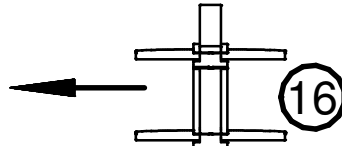
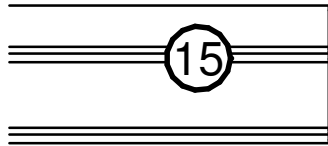

14

15

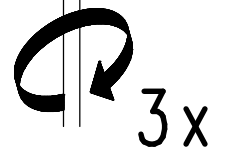
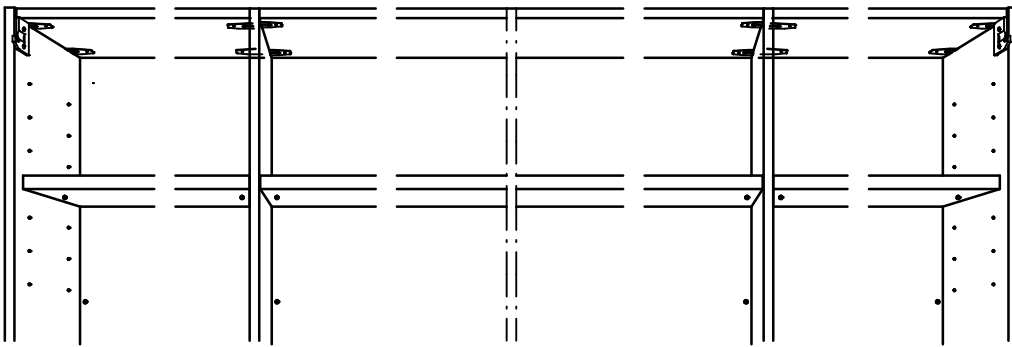

3 x

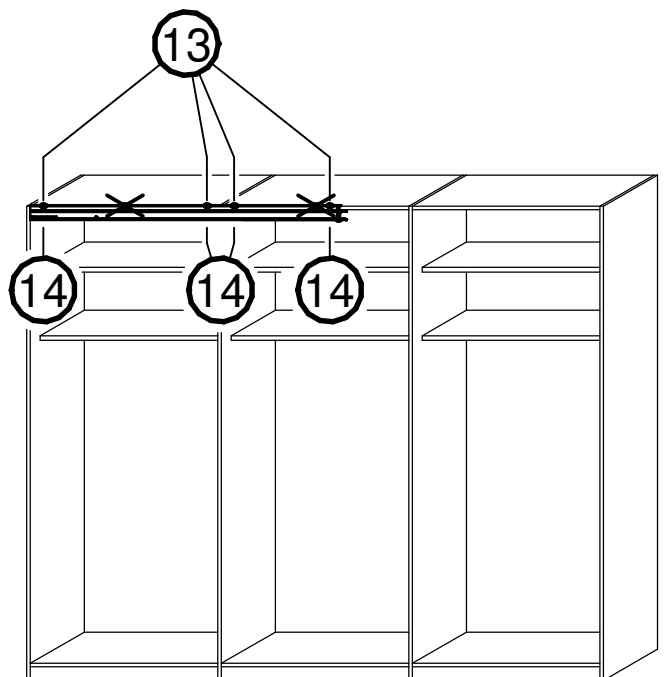
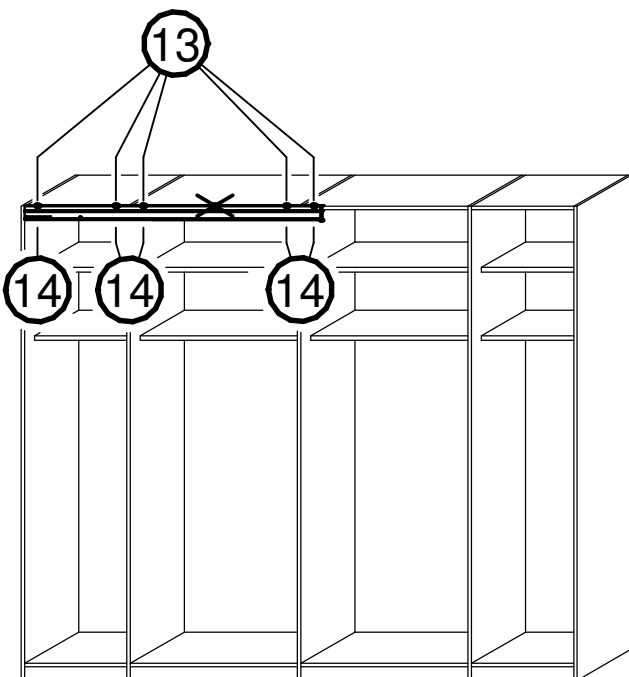

7.

660.4676.000



13

660.4677.000

M4x12



14

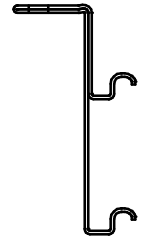

15

1 x

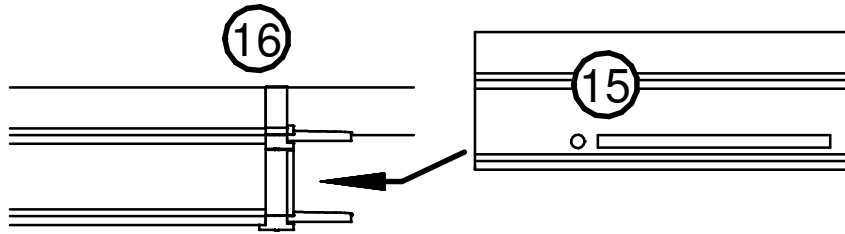

16

15

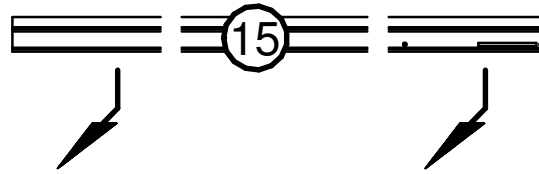

15

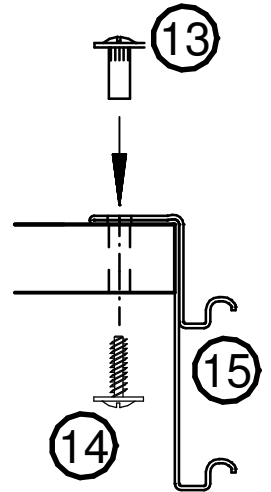

13

15

14

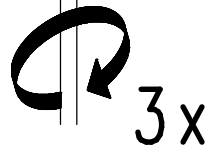

3x

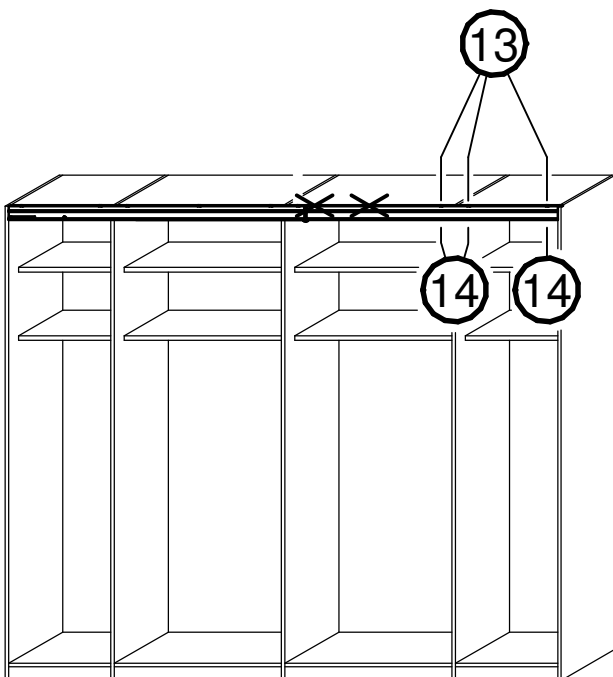
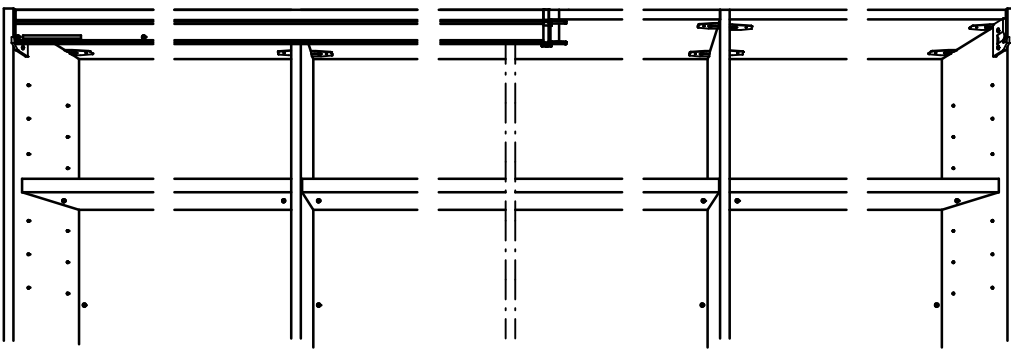

13

14

14

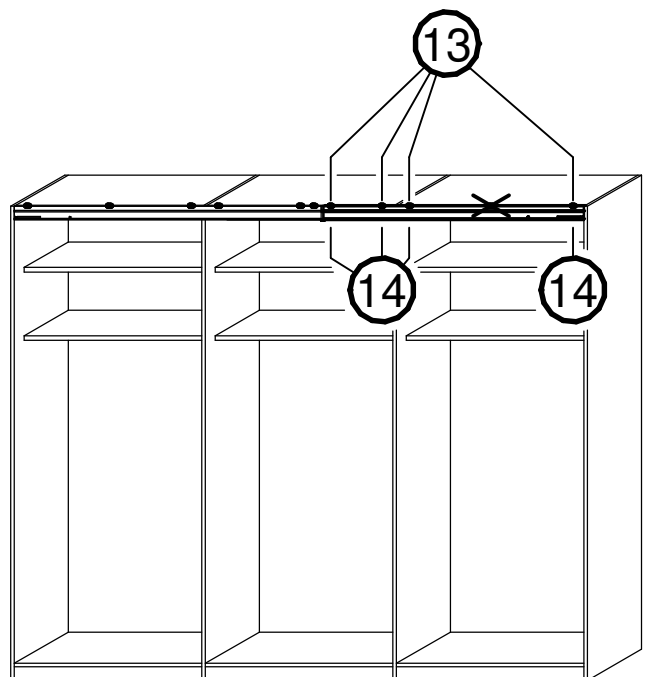

13

14

14

8.

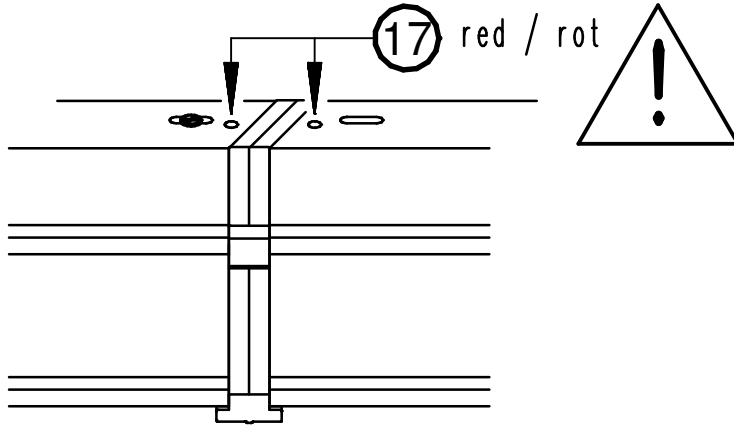

631.1101.000
4 x 15 mm

red / rot



17

2 x

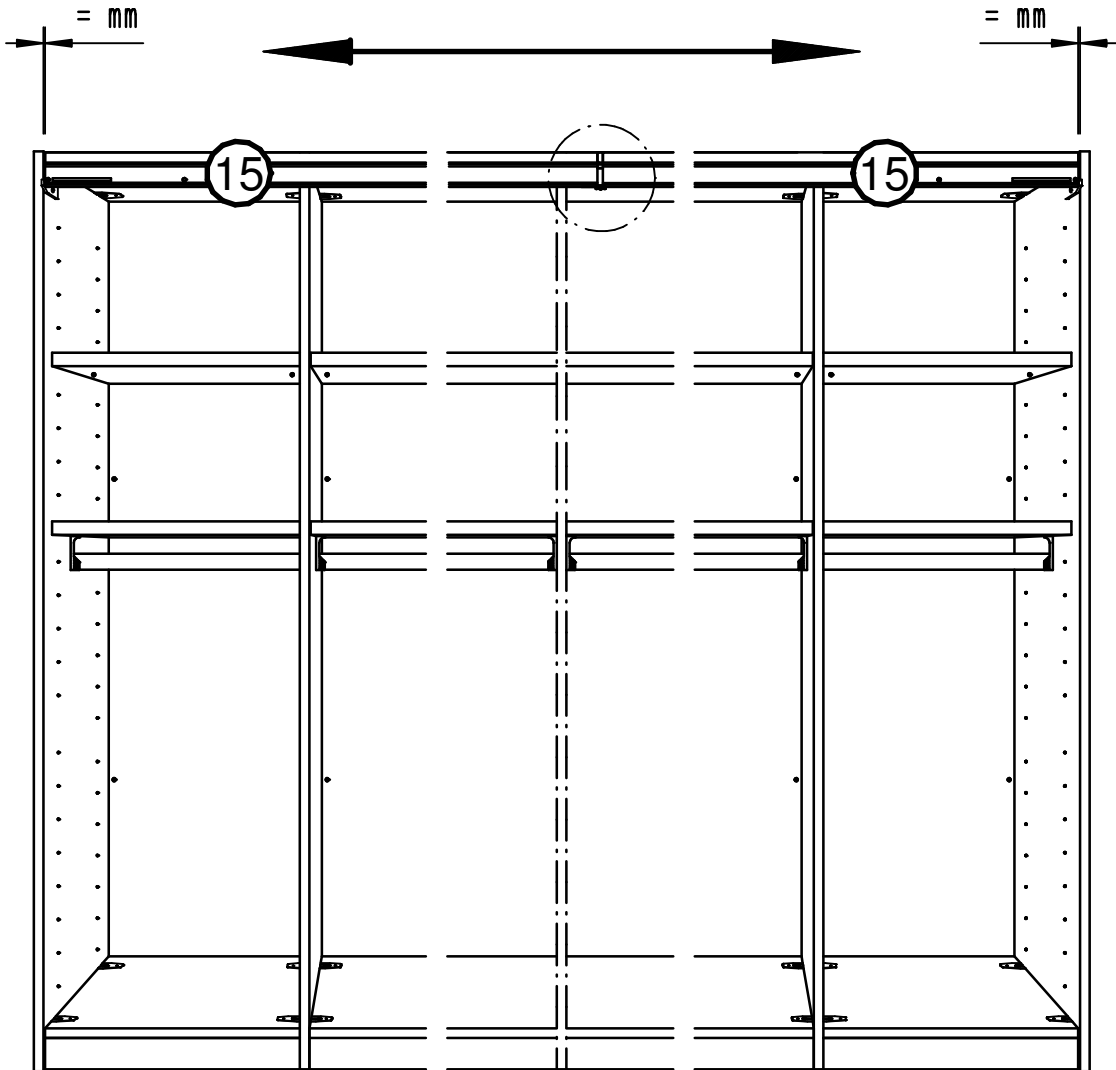

9.

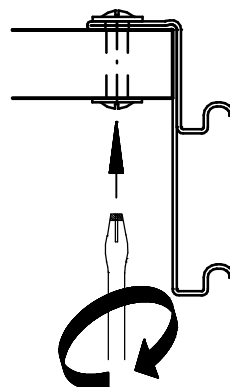
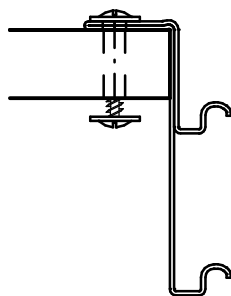

10.

660.4676.000



13

660.4677.000
M4x12



14

632.3173.000
(5K26908)

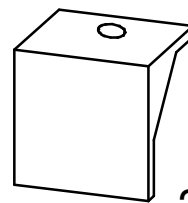

18

3 x

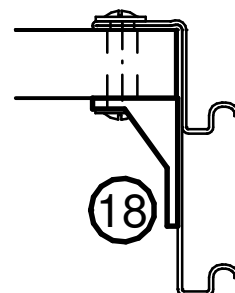
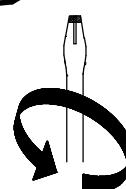
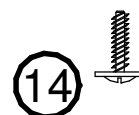
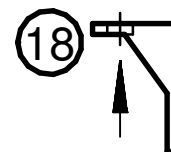
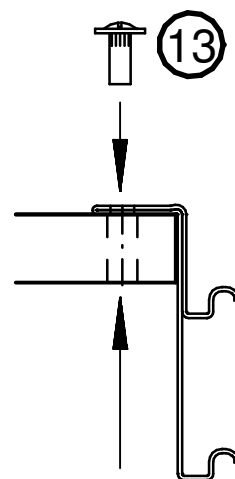
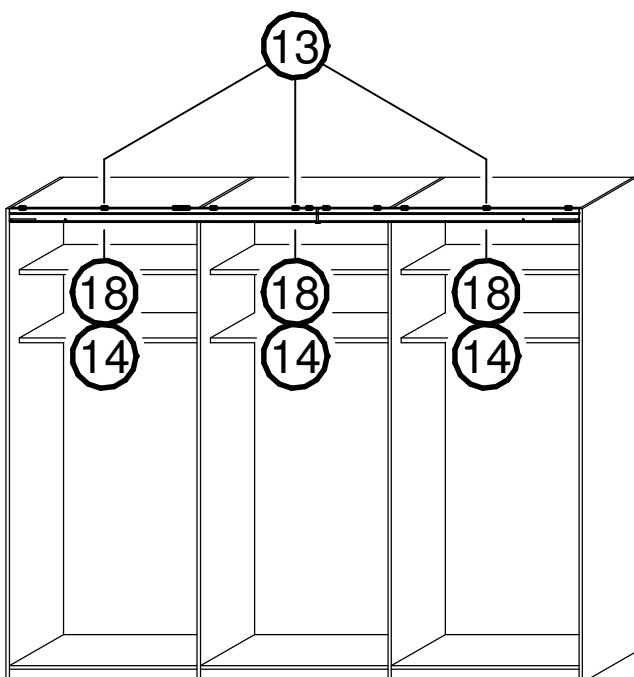
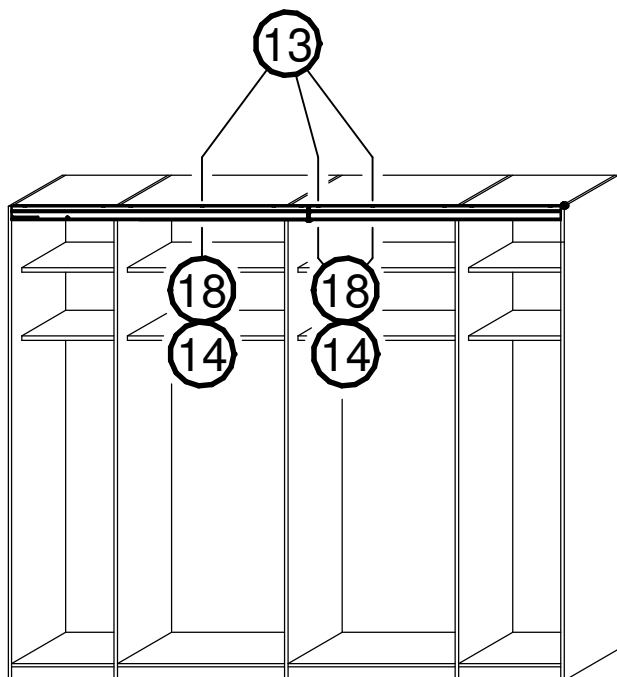

660.4686.000

2 x

M5 x 12 mm

M5

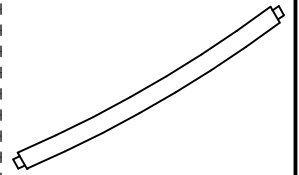
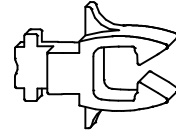
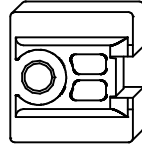
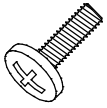

(19)

2 x

(20)

2 x

(21)

2 x

(22)

2 x

(23)

2 x

11.

1

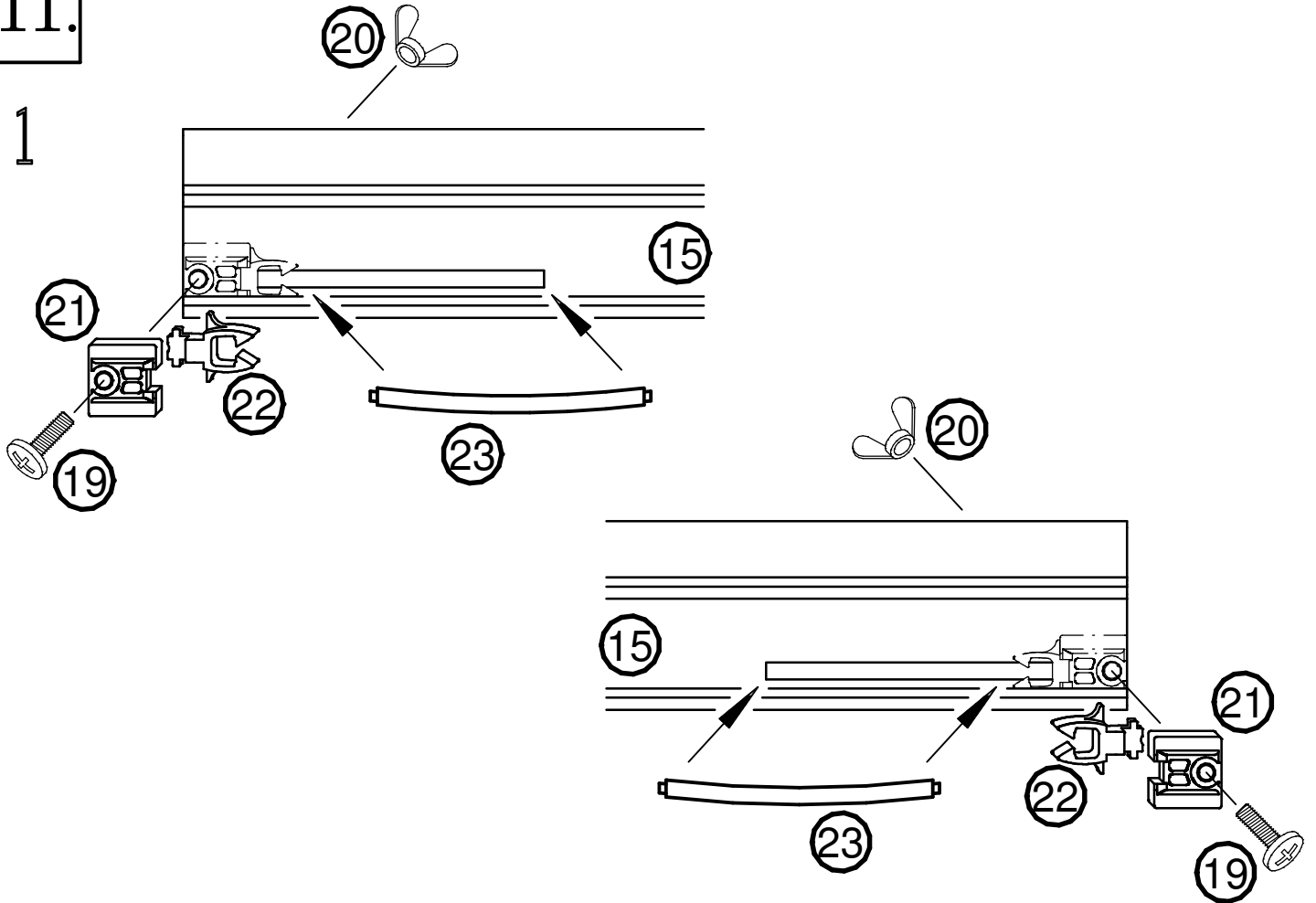

2

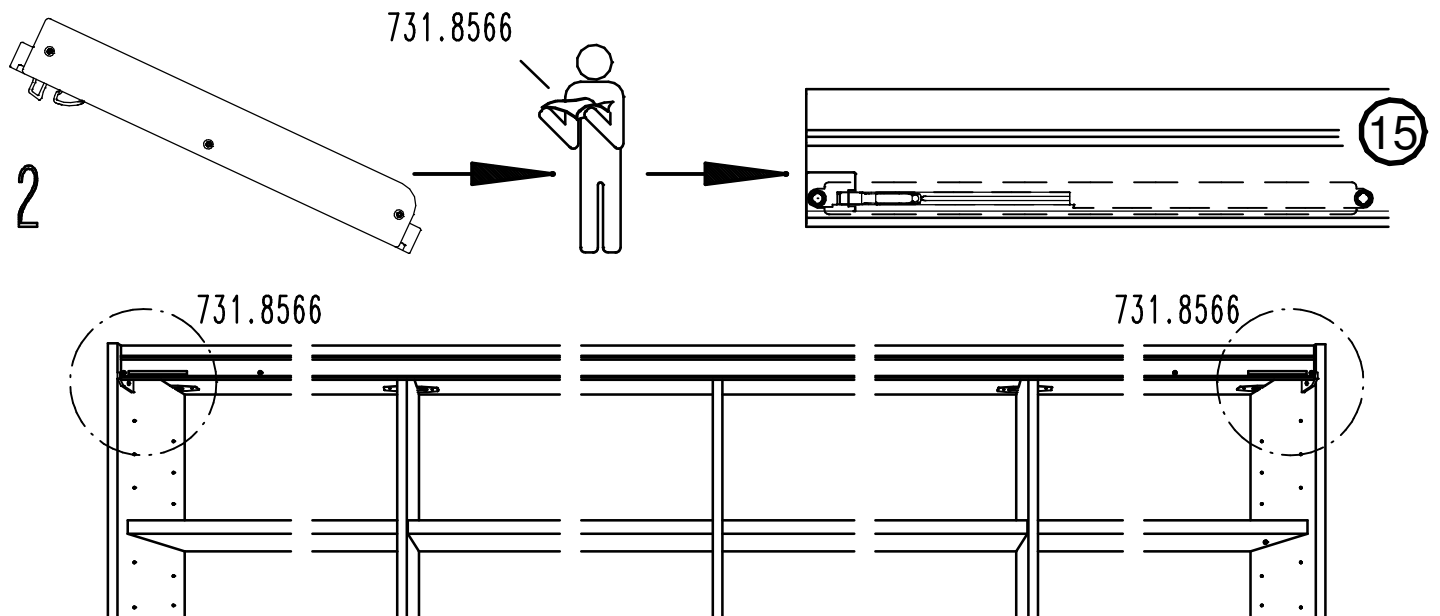

12.

660.4742.000

660.4669.000

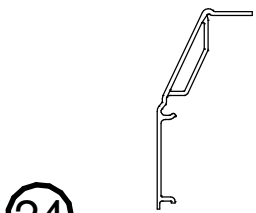

24

2 x

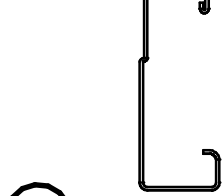

25

1 x

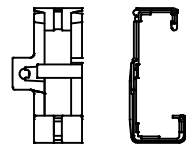

26

1 x

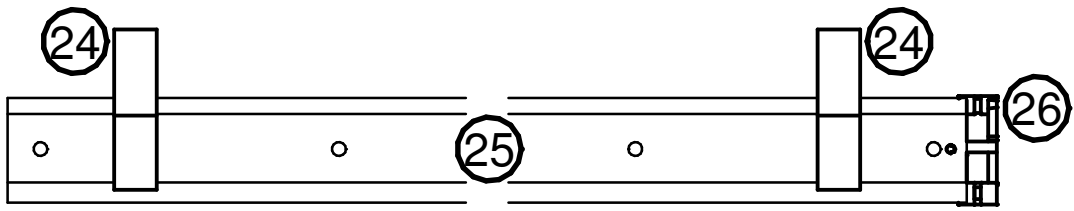
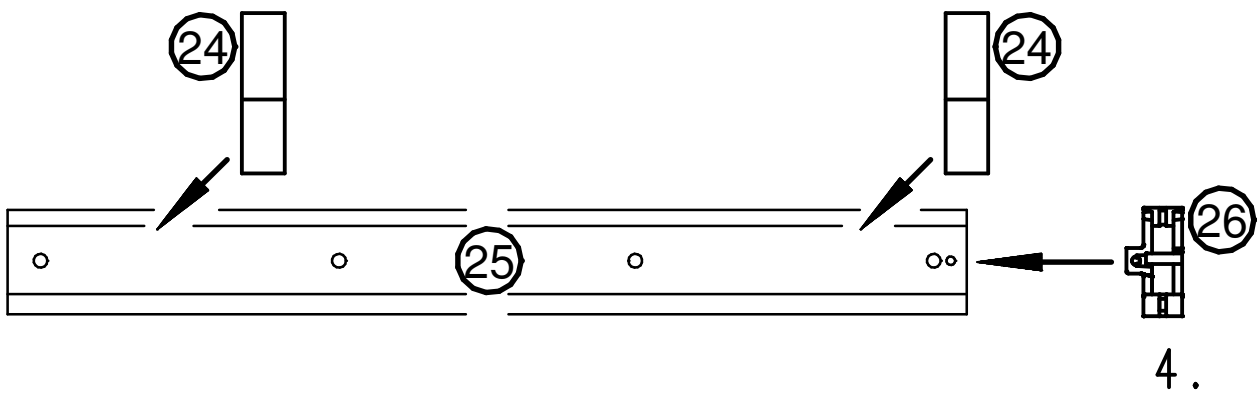
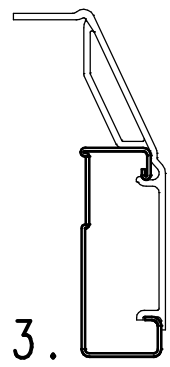
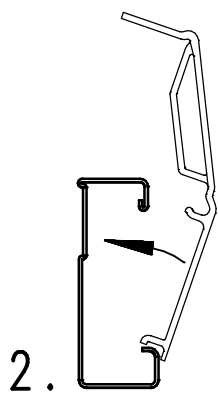
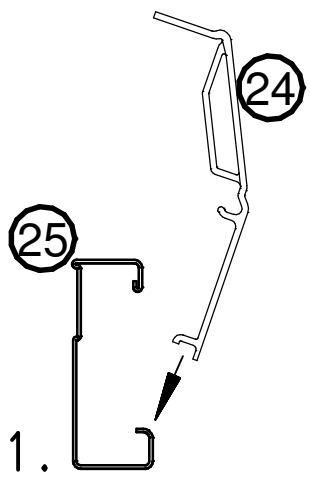

13.

632.0038.000
4 x 14 mm

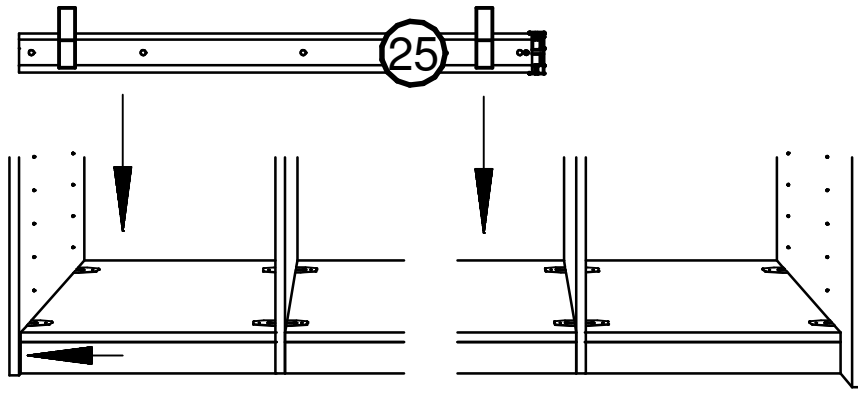

②

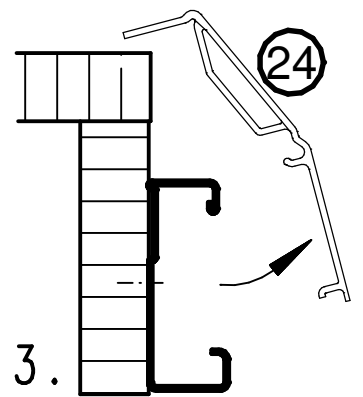
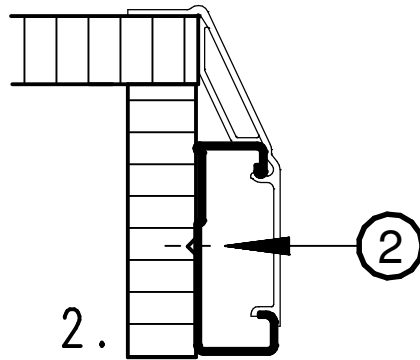
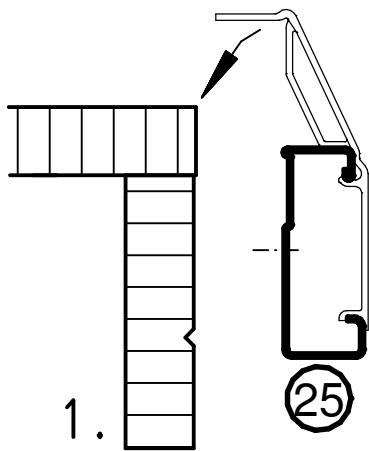

14.

660.4742.000

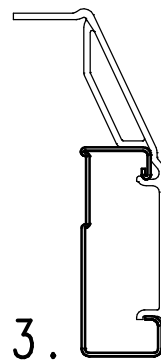
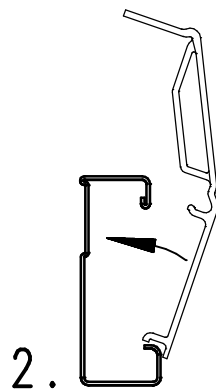
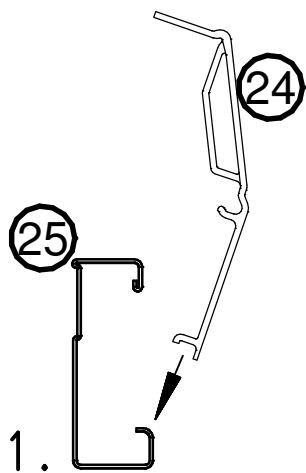

②④

2 x

②⑤

1 x

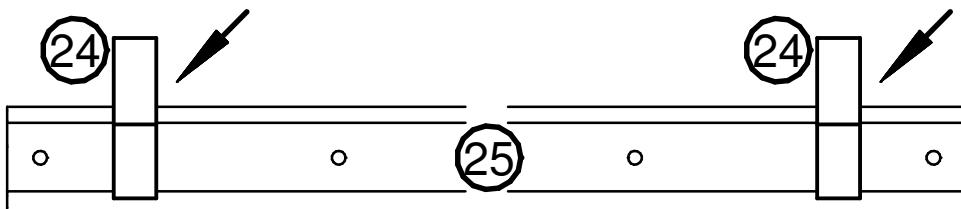

15.

632.0038.000
4 x 14 mm



②

