

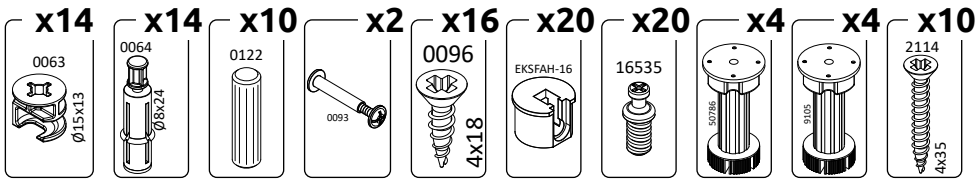

IMPORTANT - READ CAREFULLY - RETAIN FOR FUTURE REFERENCE  
WICHTIG - SORGFÄLTIG LESEN UND AUFBEWAHREN

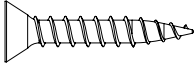
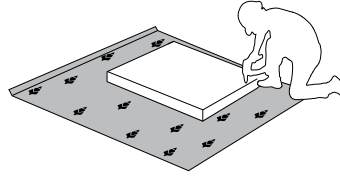
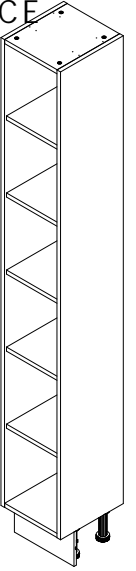

**K21-30-LP**

LHW-316X2190X300

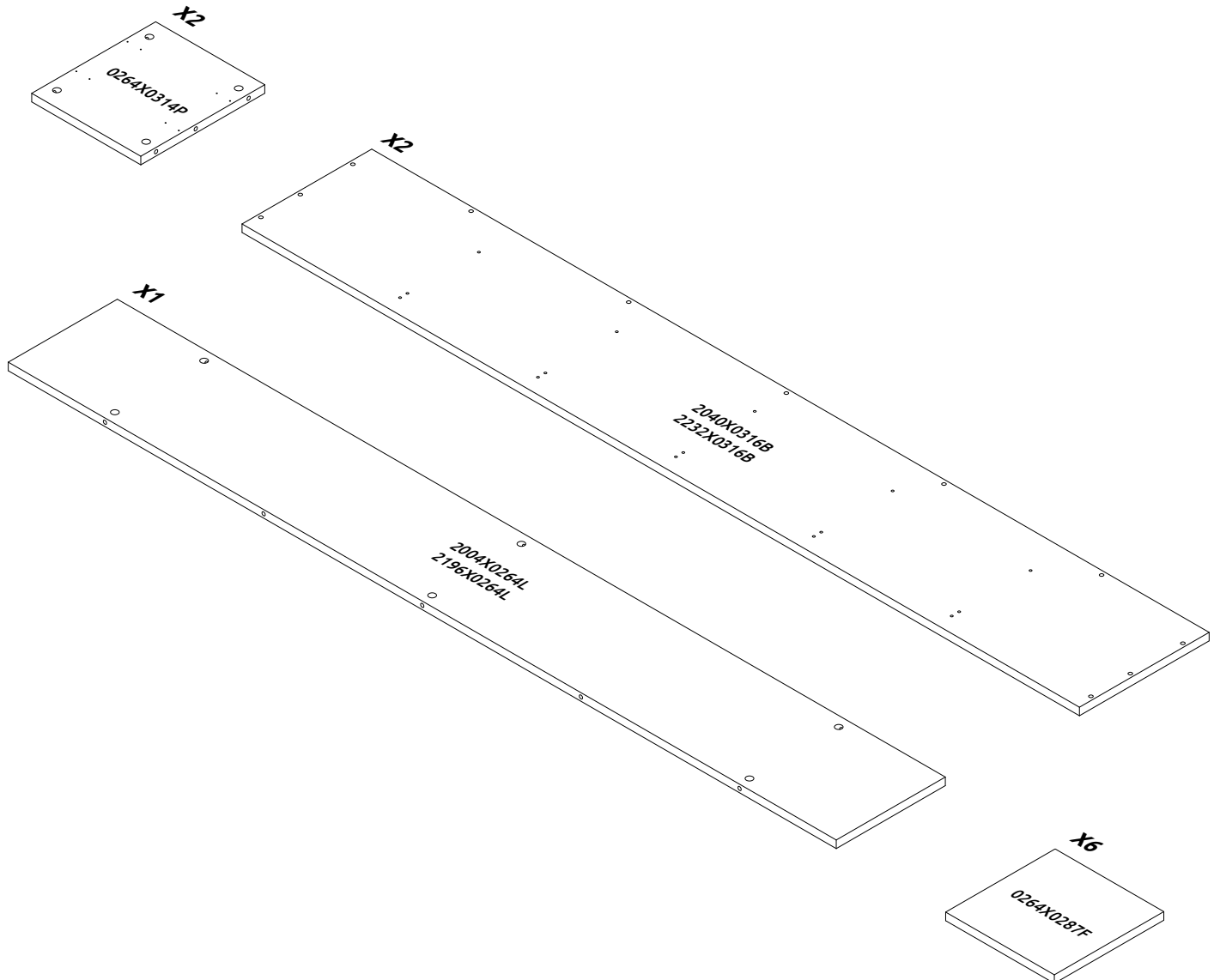

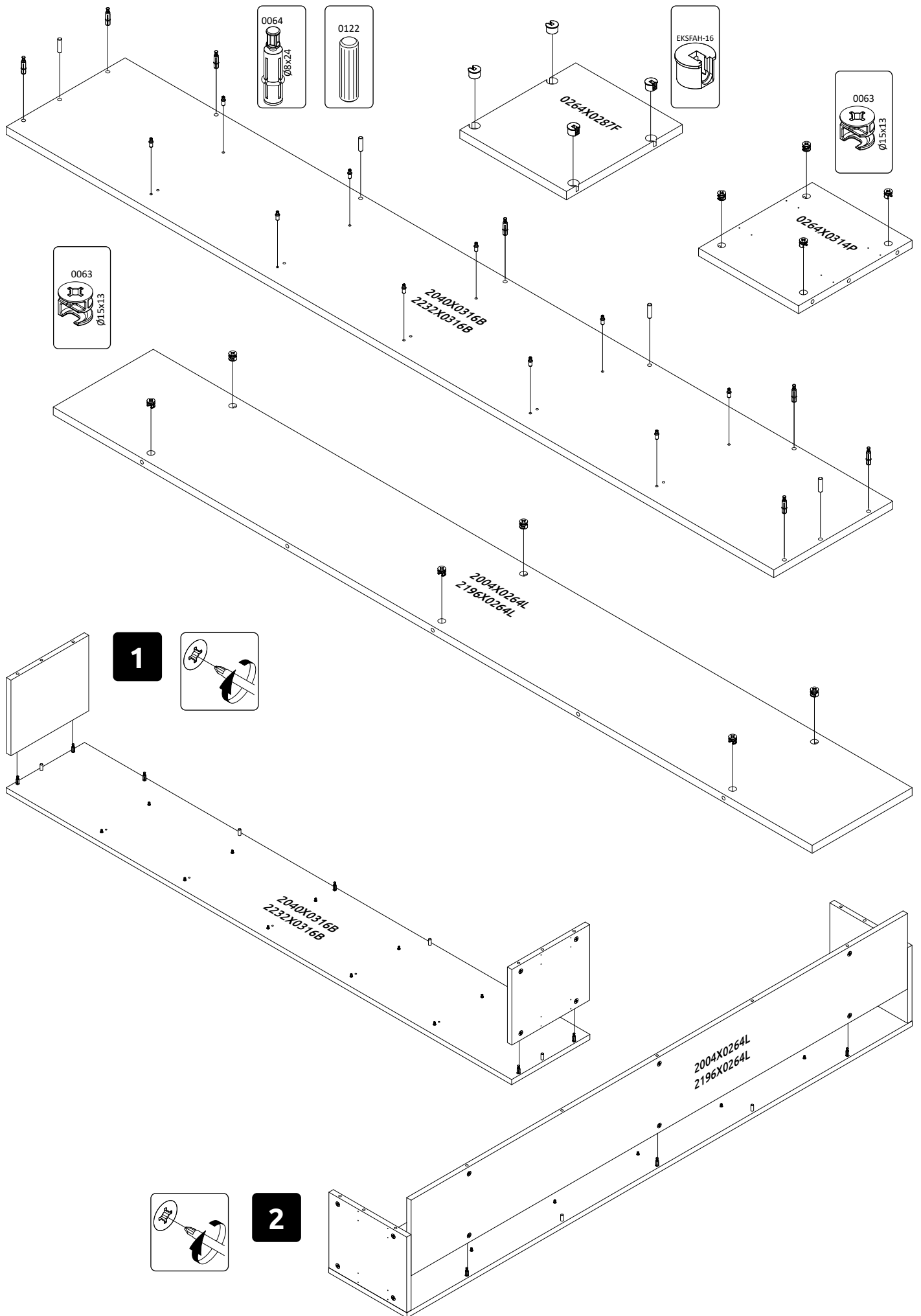



**3**

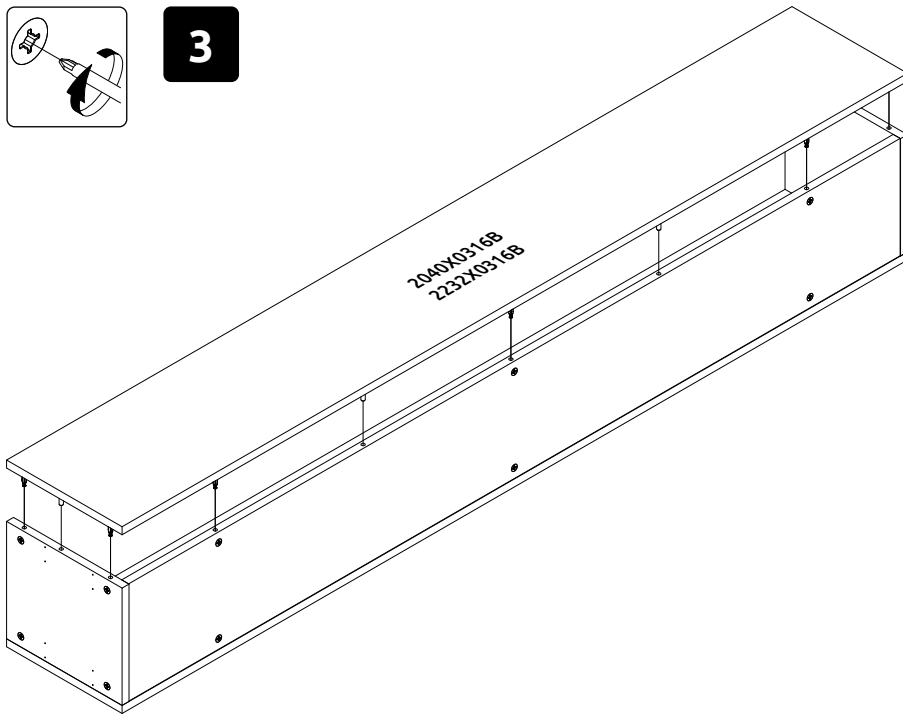

**4**

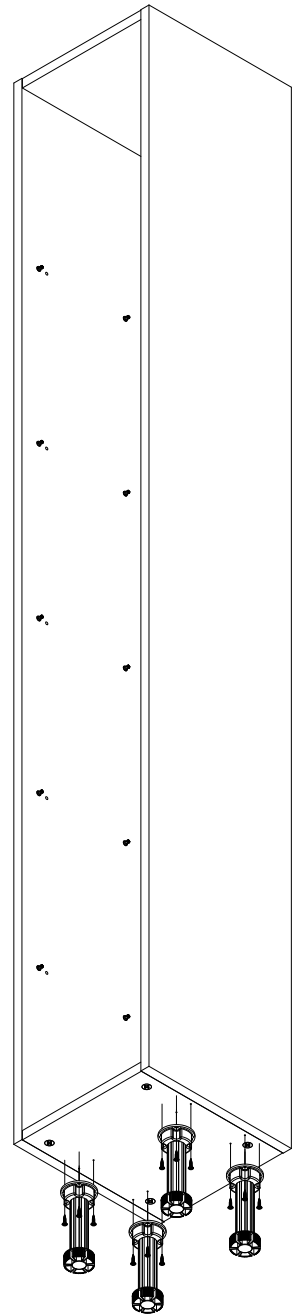

**5**

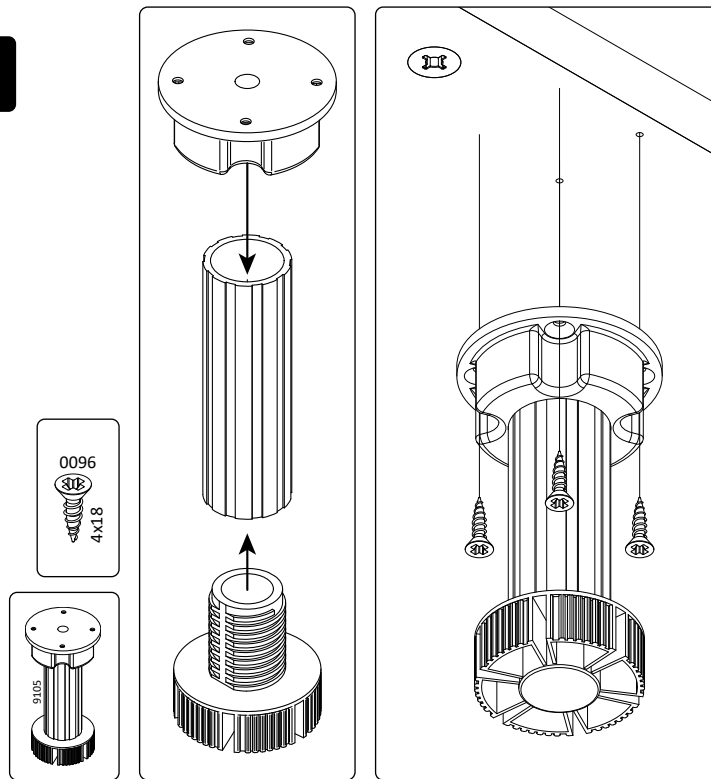
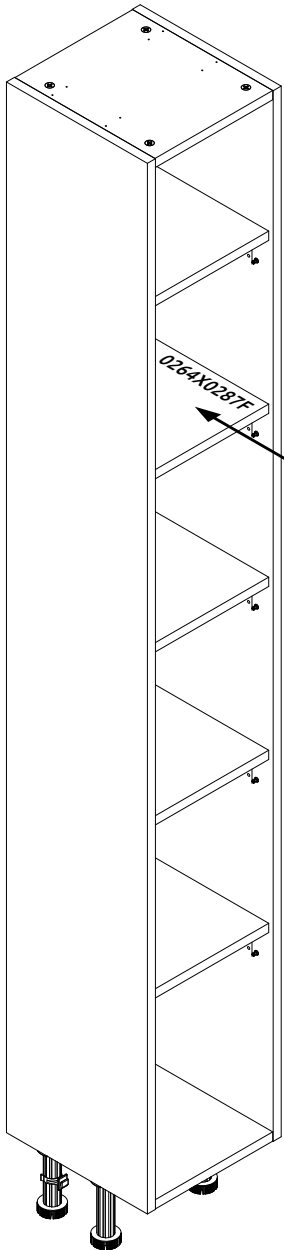

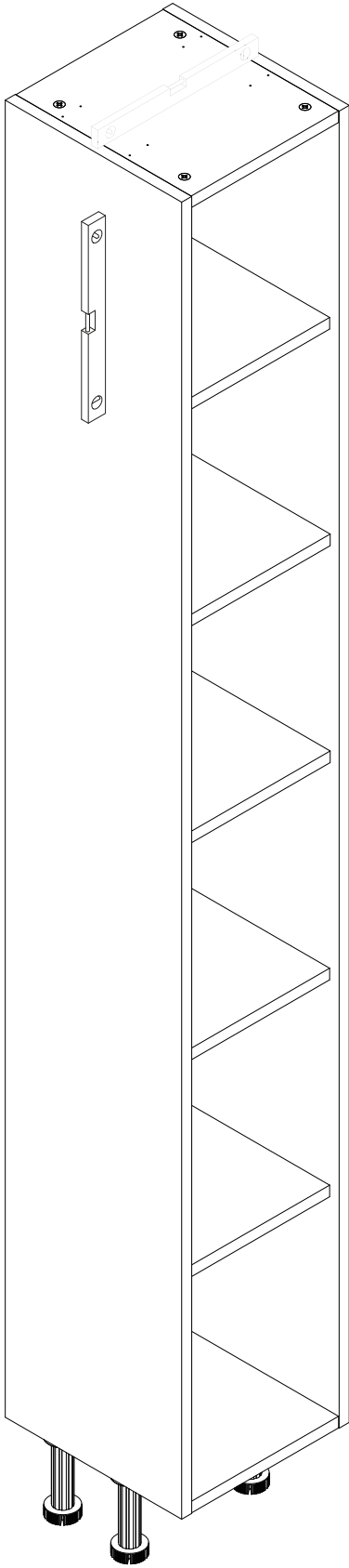

**6**

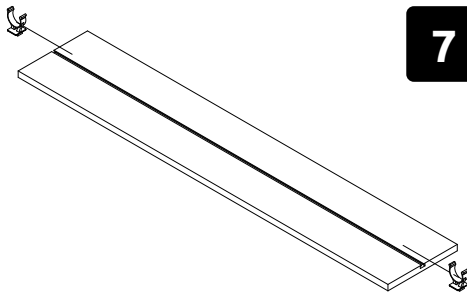
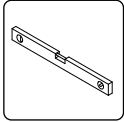
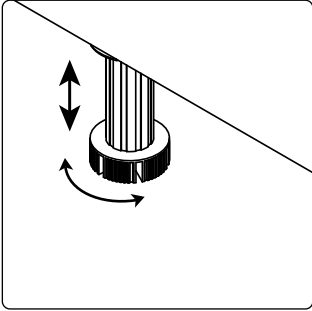

**7**

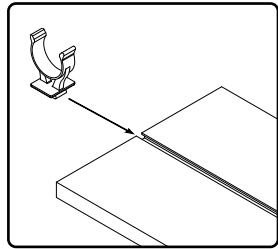

**8**

