

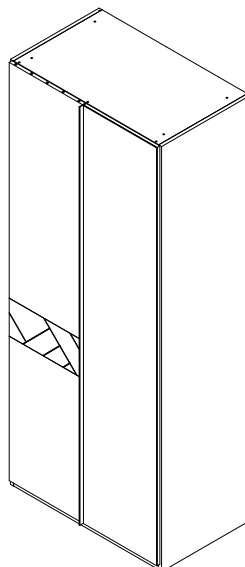

IMPORTANT - READ CAREFULLY - RETAIN FOR FUTURE REFERENCE  
WICHTIG - SORGFÄLTIG LESEN UND AUFBEWAHREN

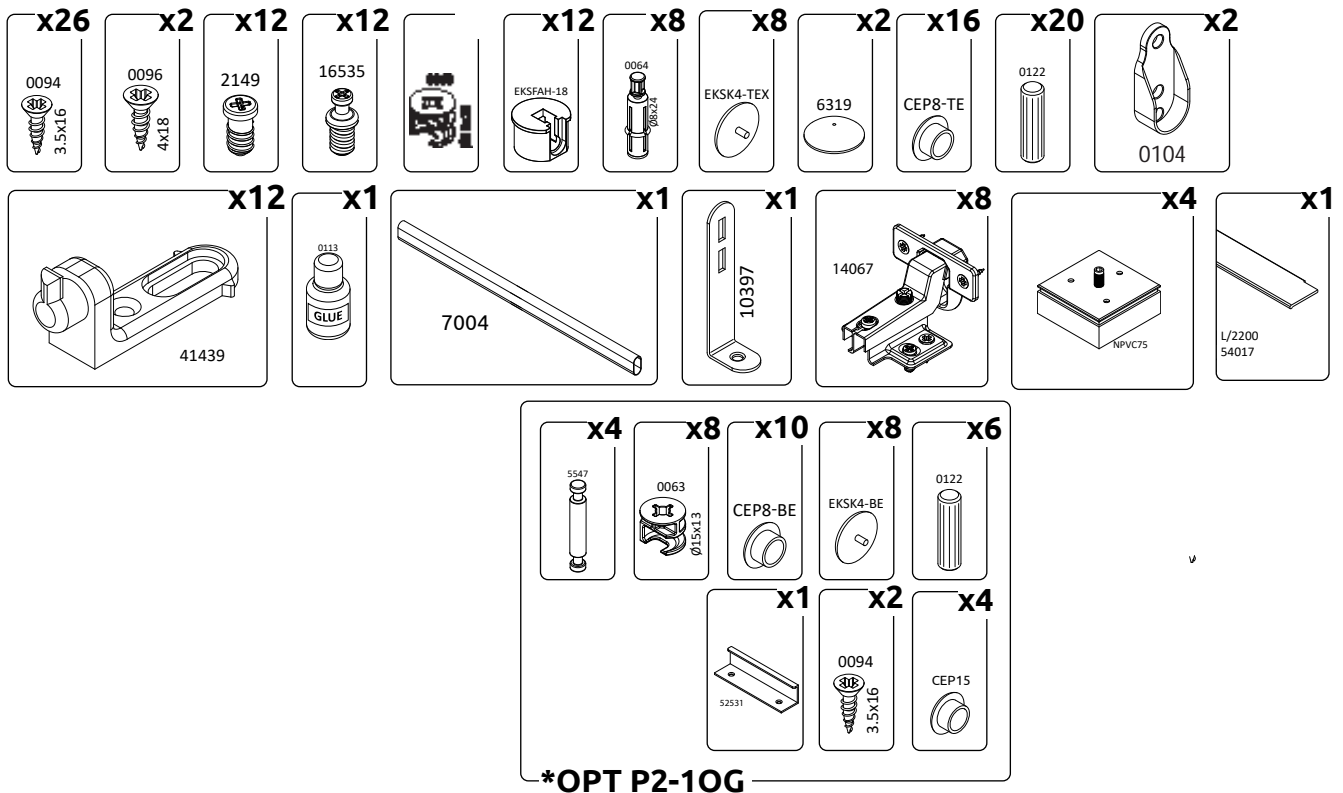

**P2-10G/AV**  
LWH - 918x555x2236

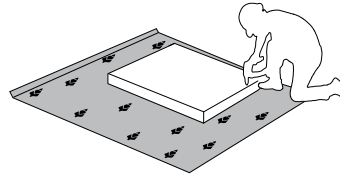
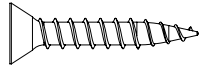
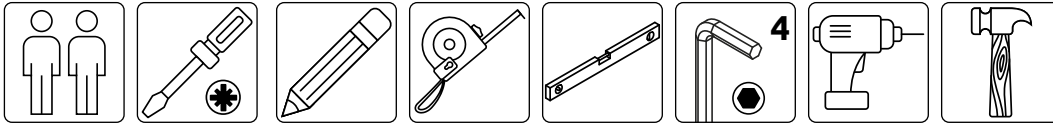

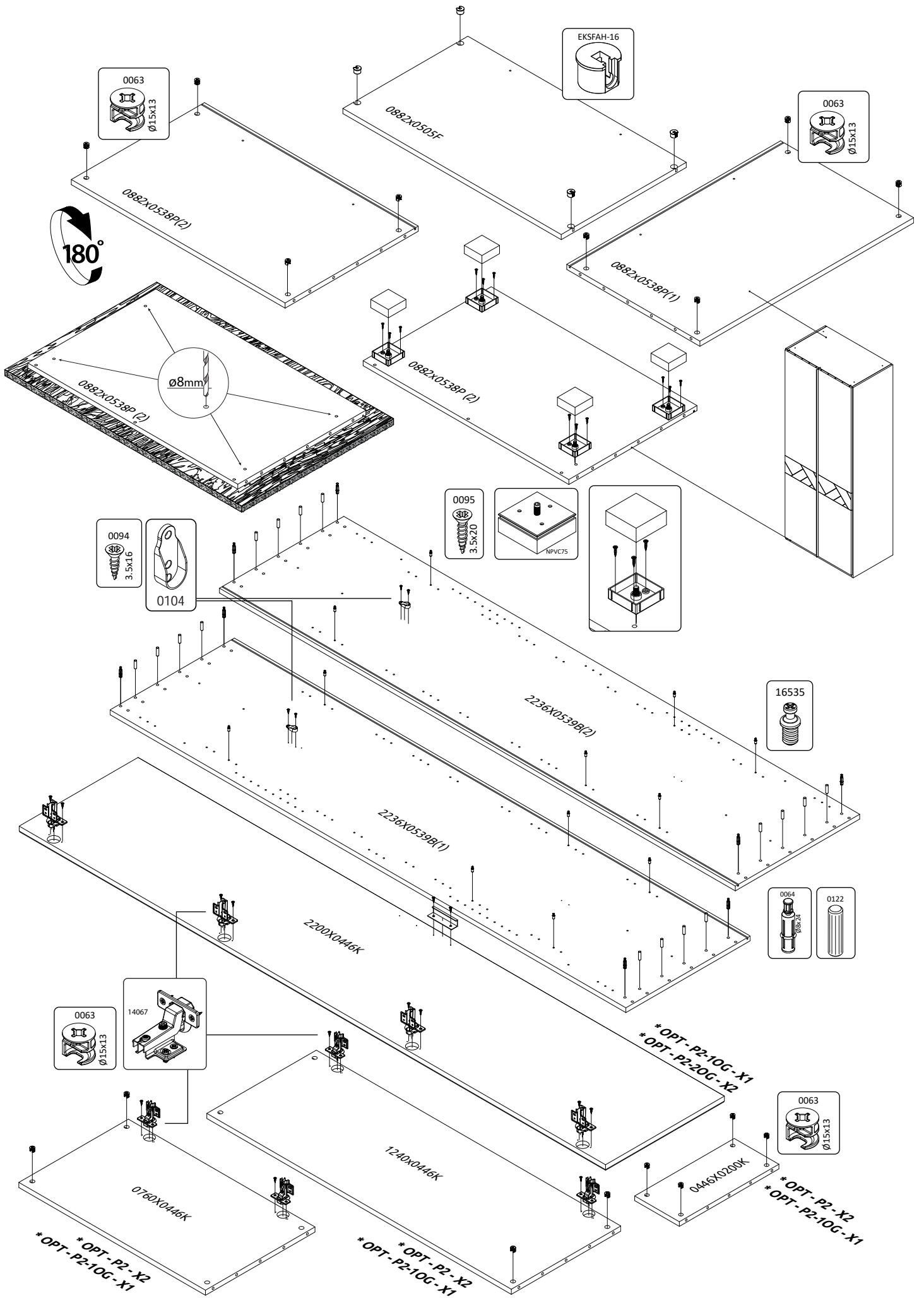

1

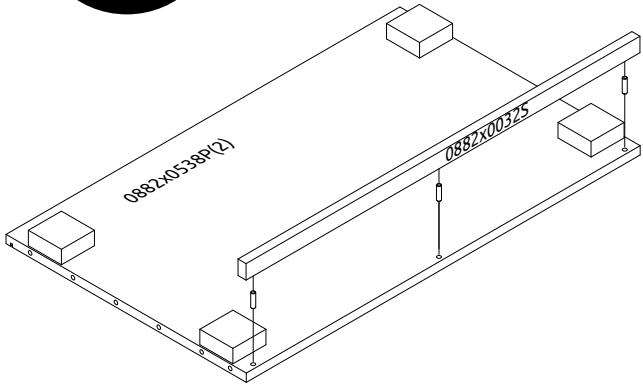
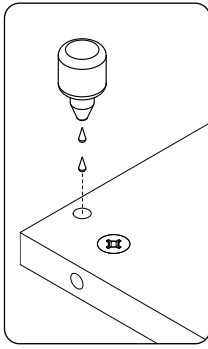
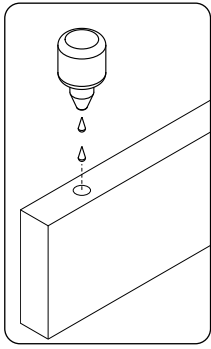
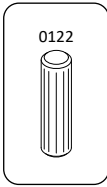

2

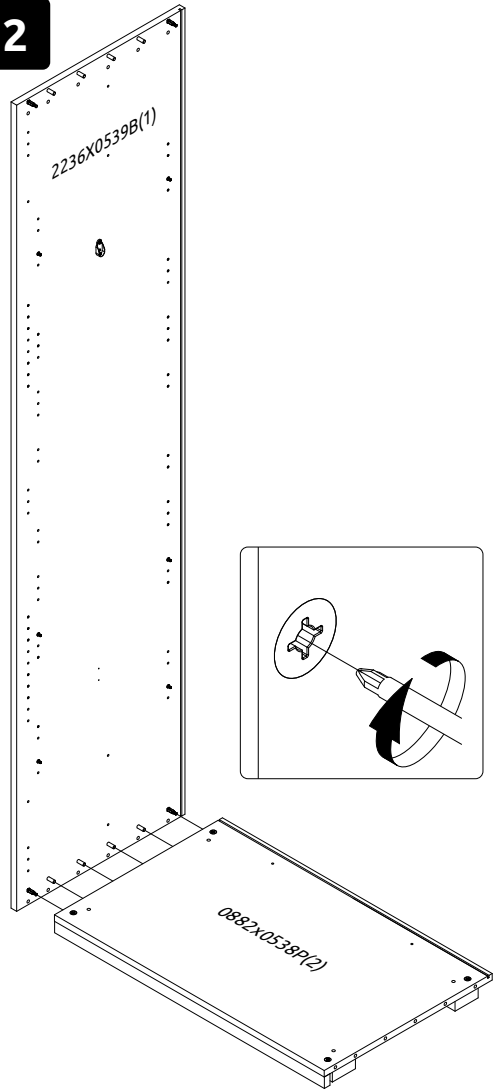

3

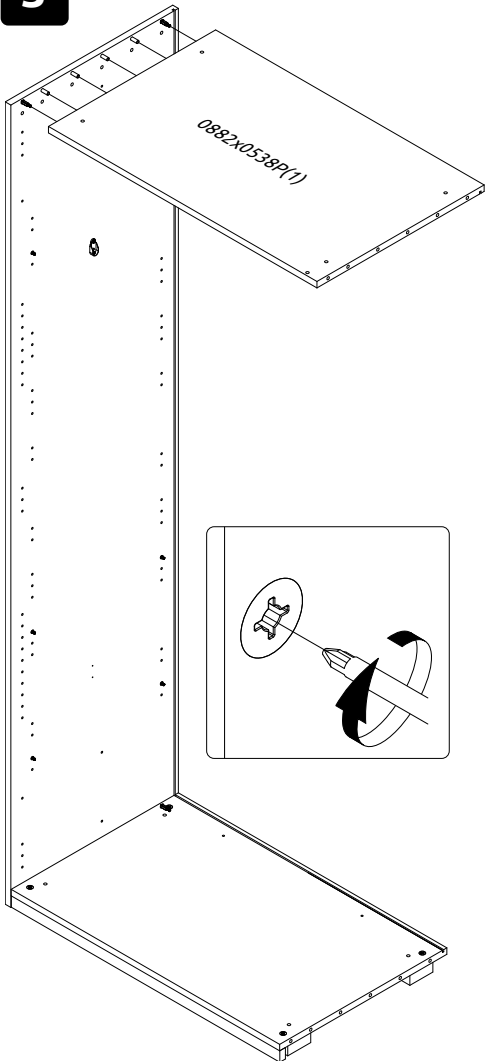

4

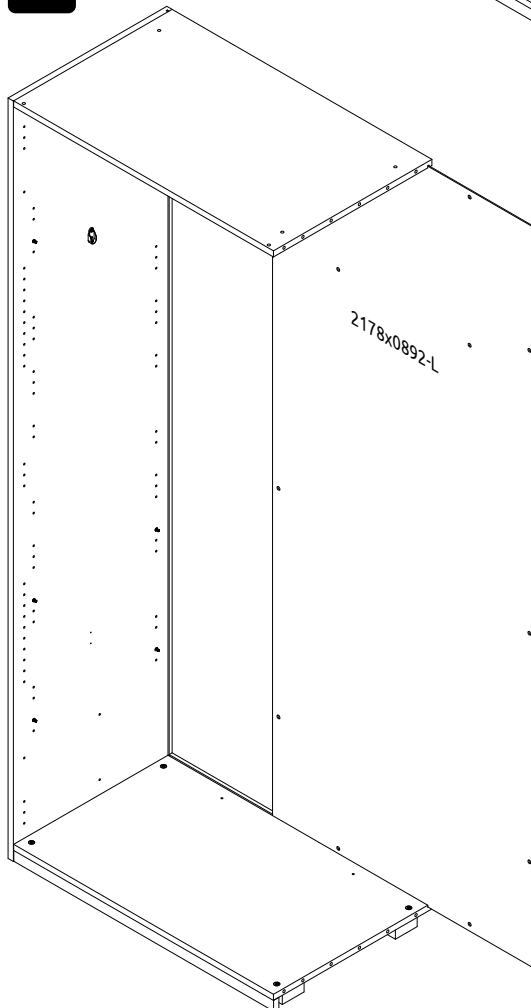

5



\*opt 1

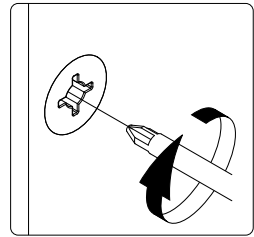
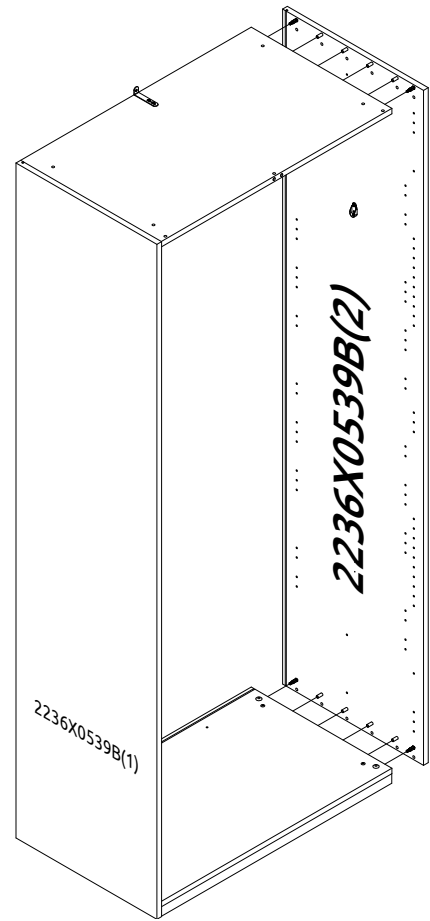
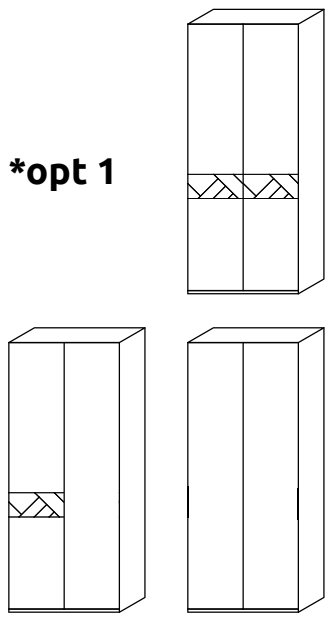

\*opt 2

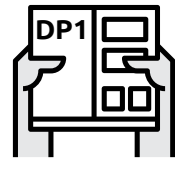
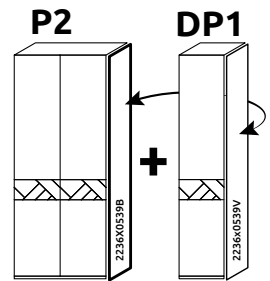

\*opt 3

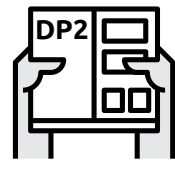
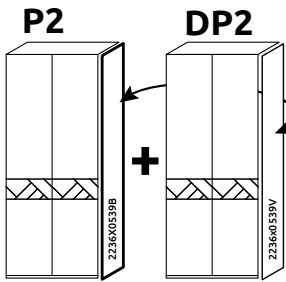

\*opt 4

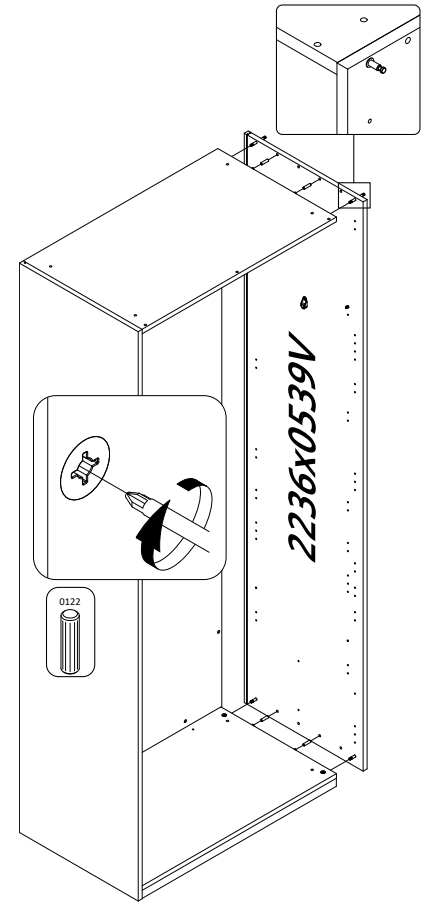
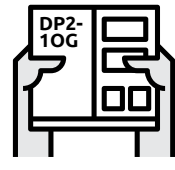
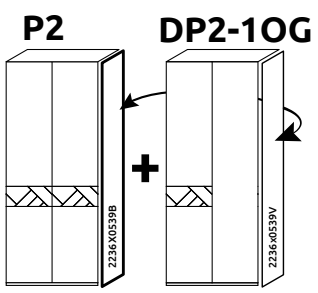

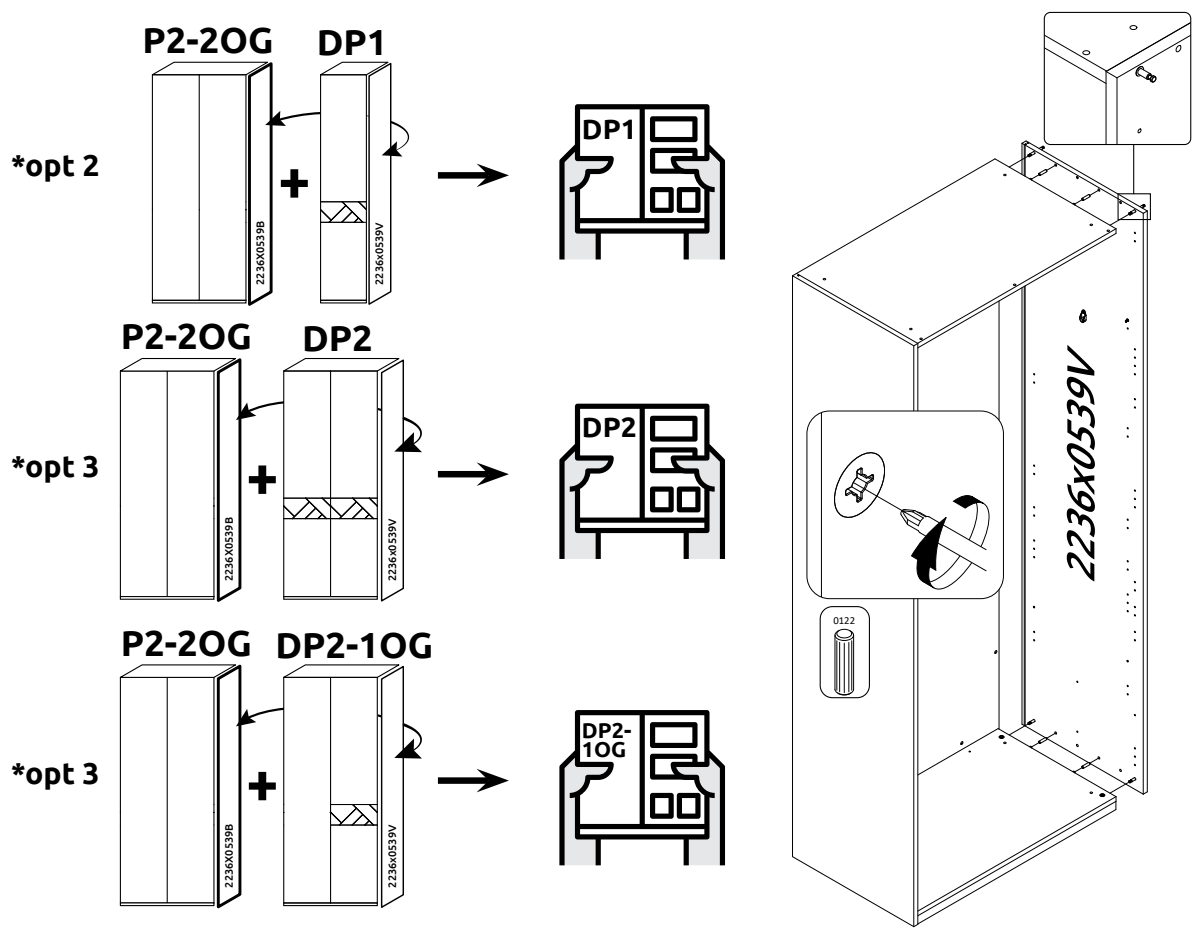
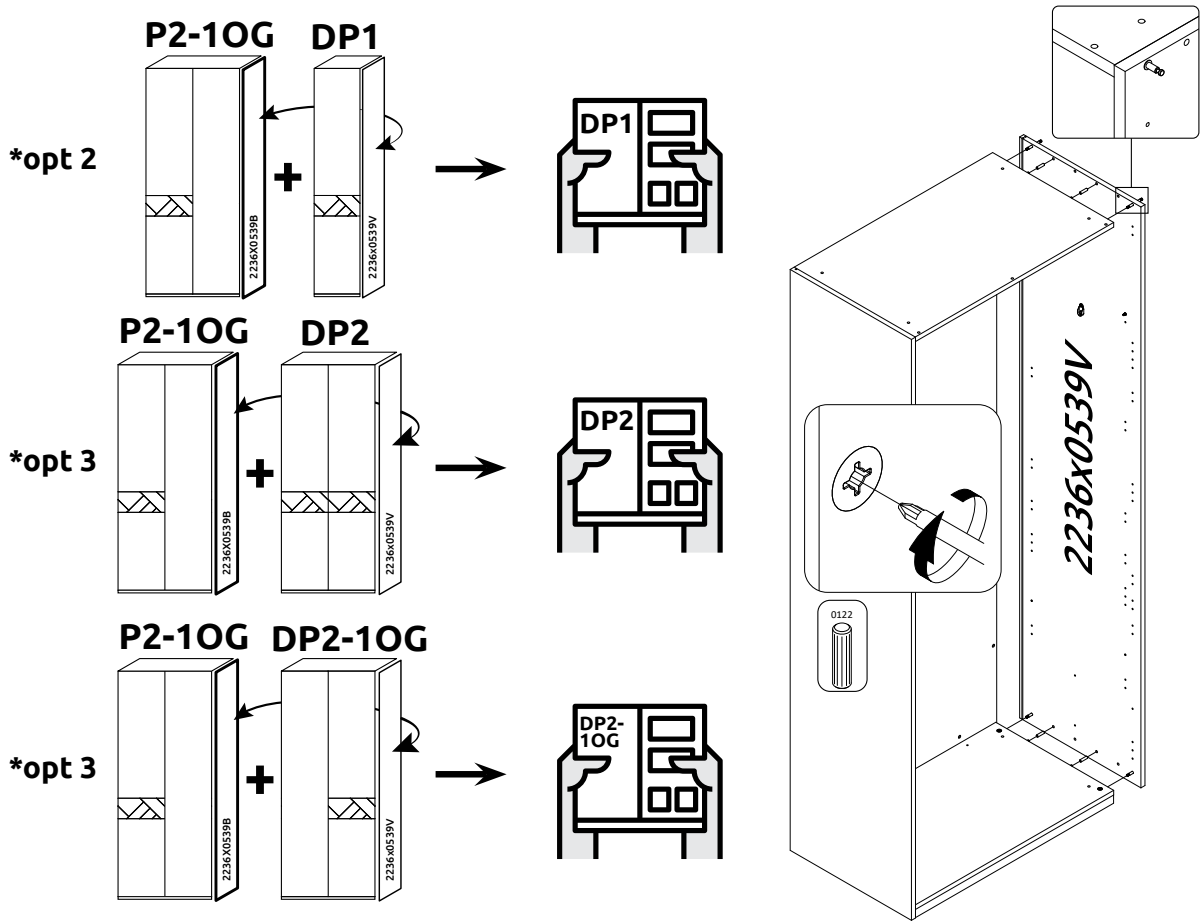

6

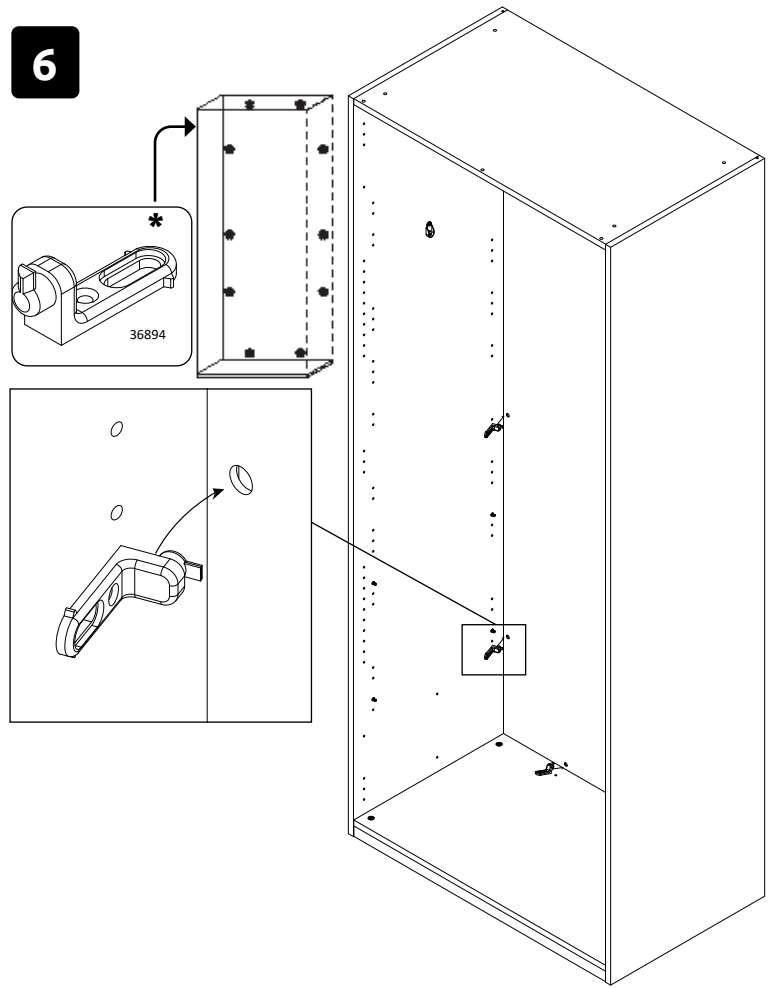

7

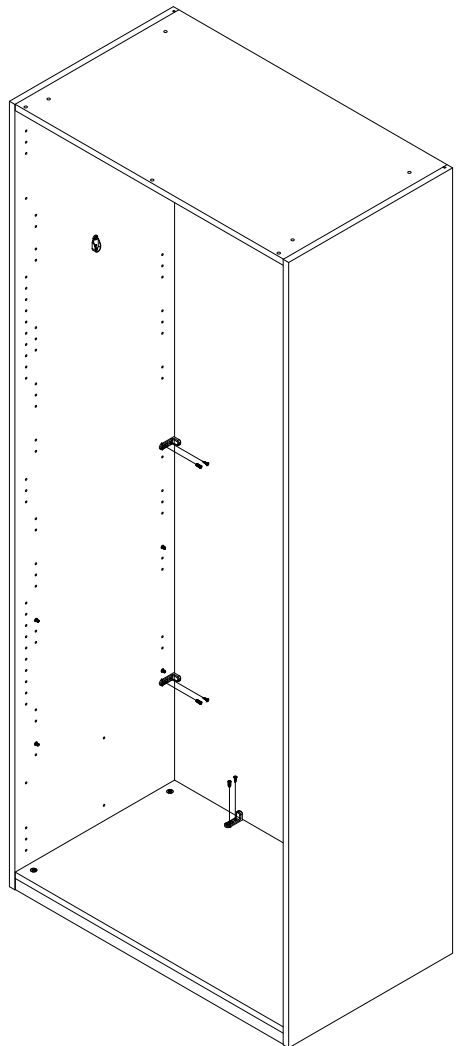
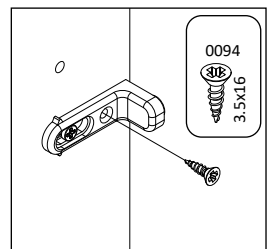
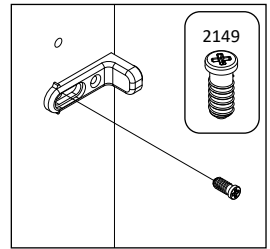
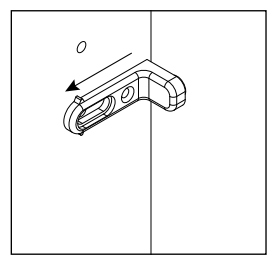

8

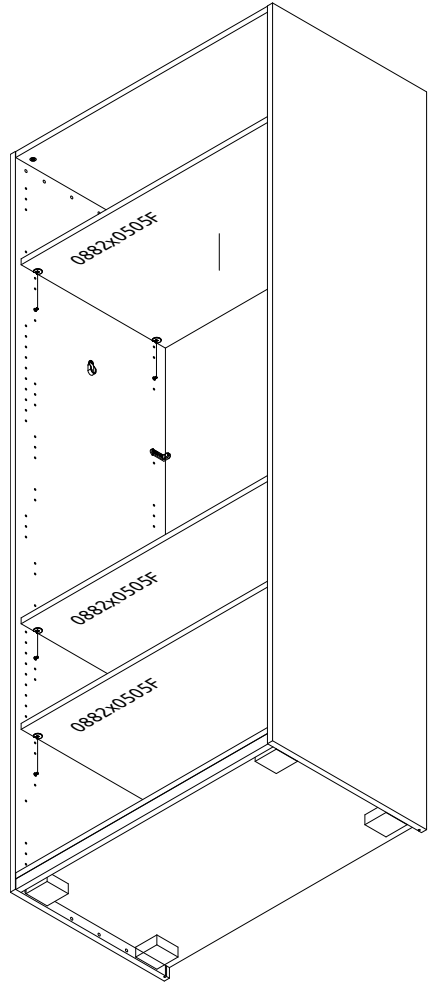

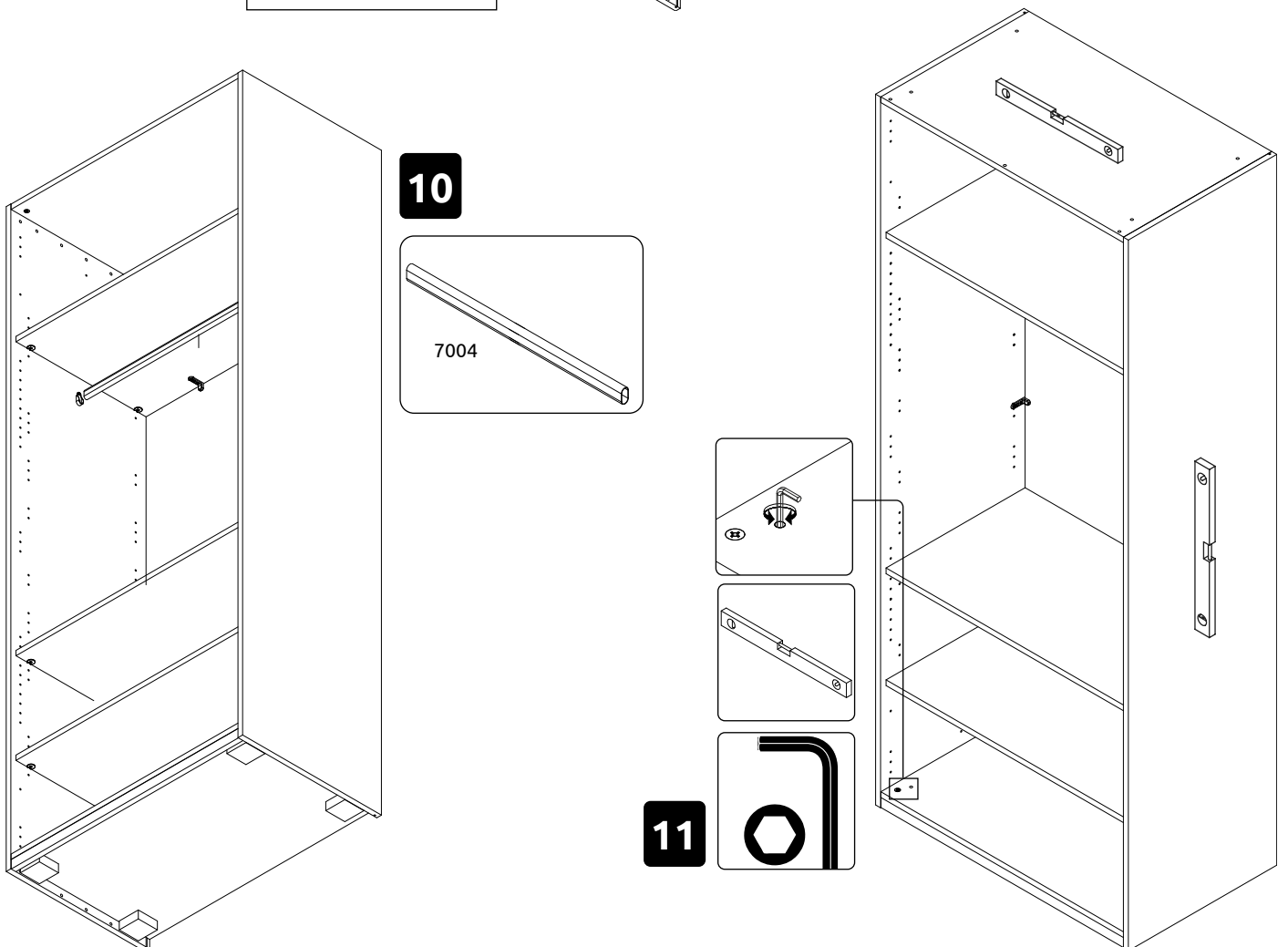
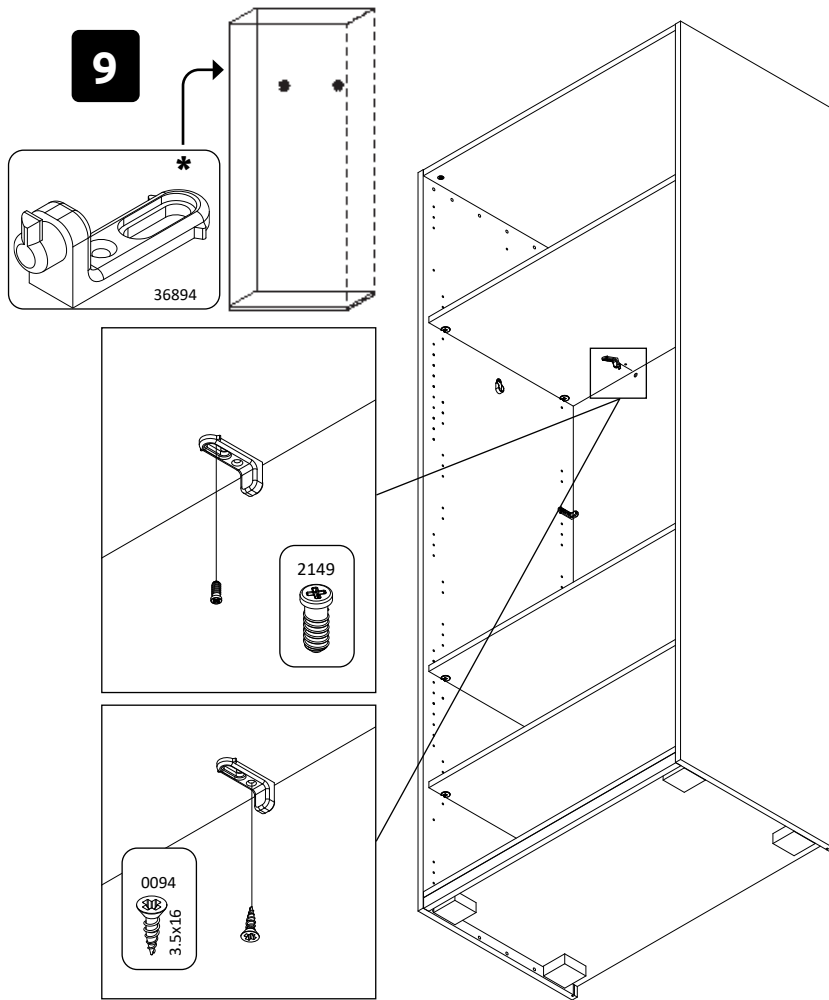



\* OPT - P2 - X2  
 \* OPT - P2-10G - X1

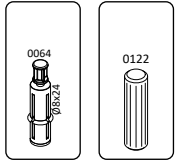

**12**

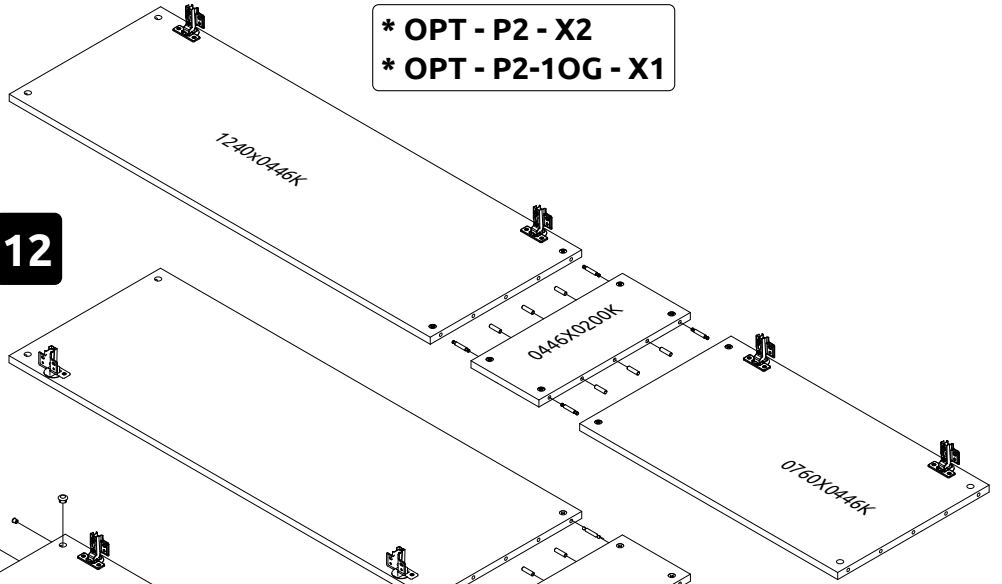

\* OPT - P2 - X2  
 \* OPT - P2-10G - X1

**13**

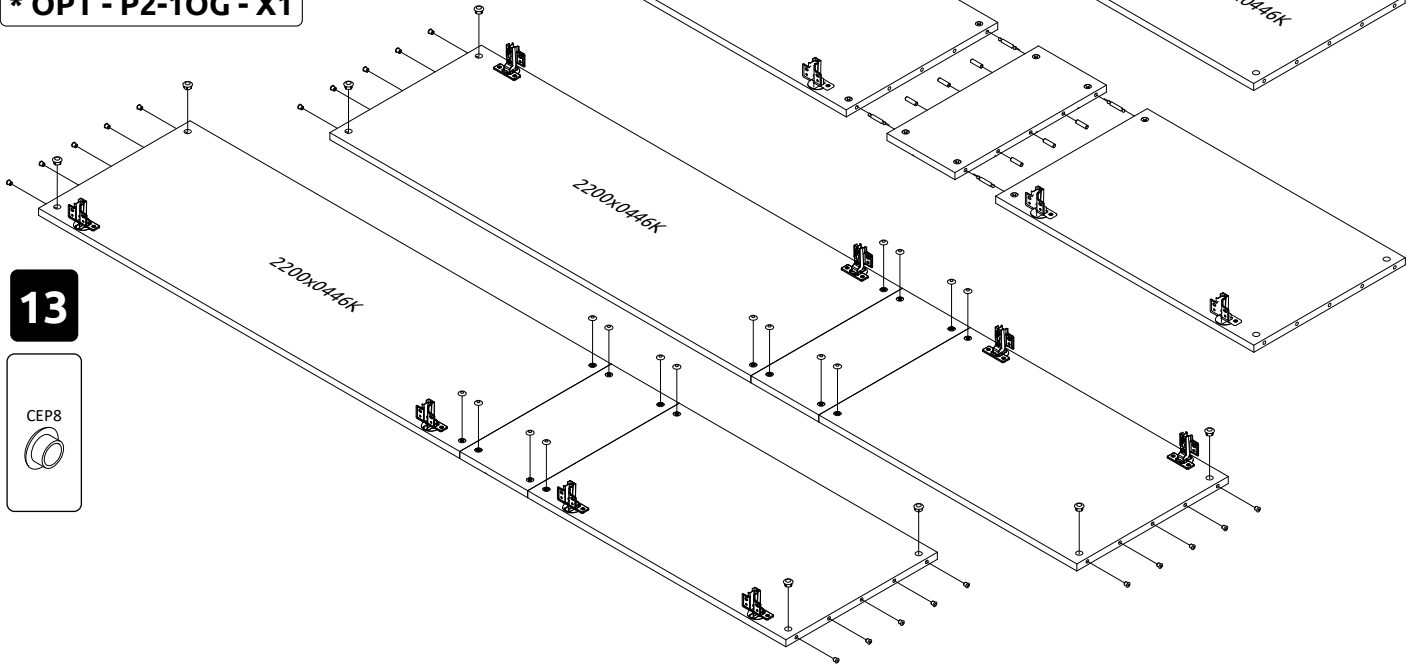

\* OPT - P2

**14**

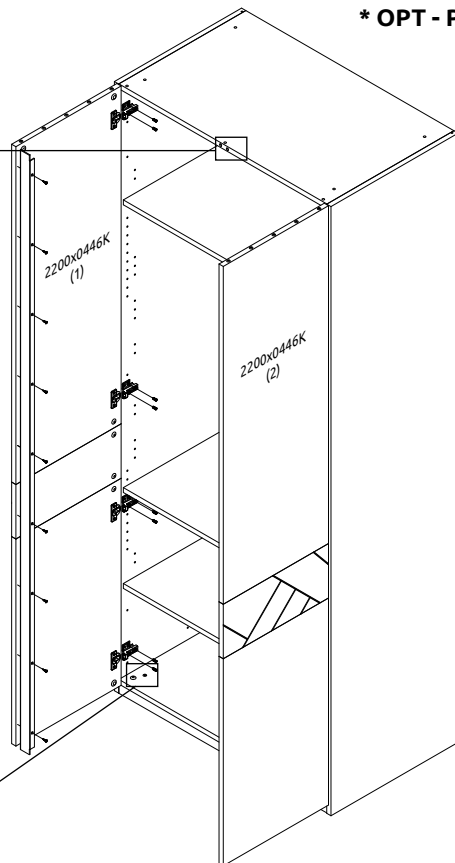
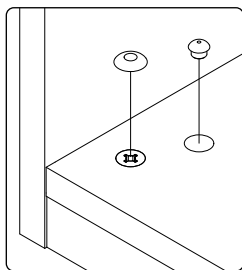
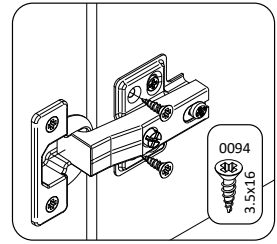
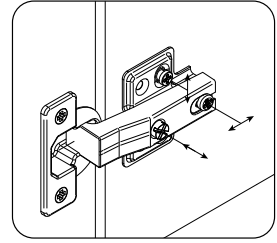
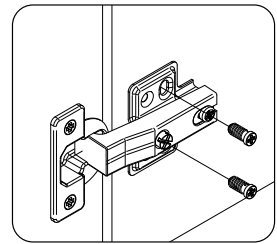
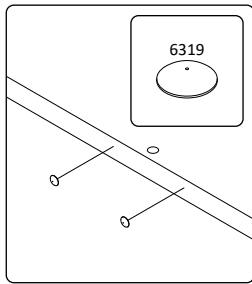

**\* OPT - P2-10G**

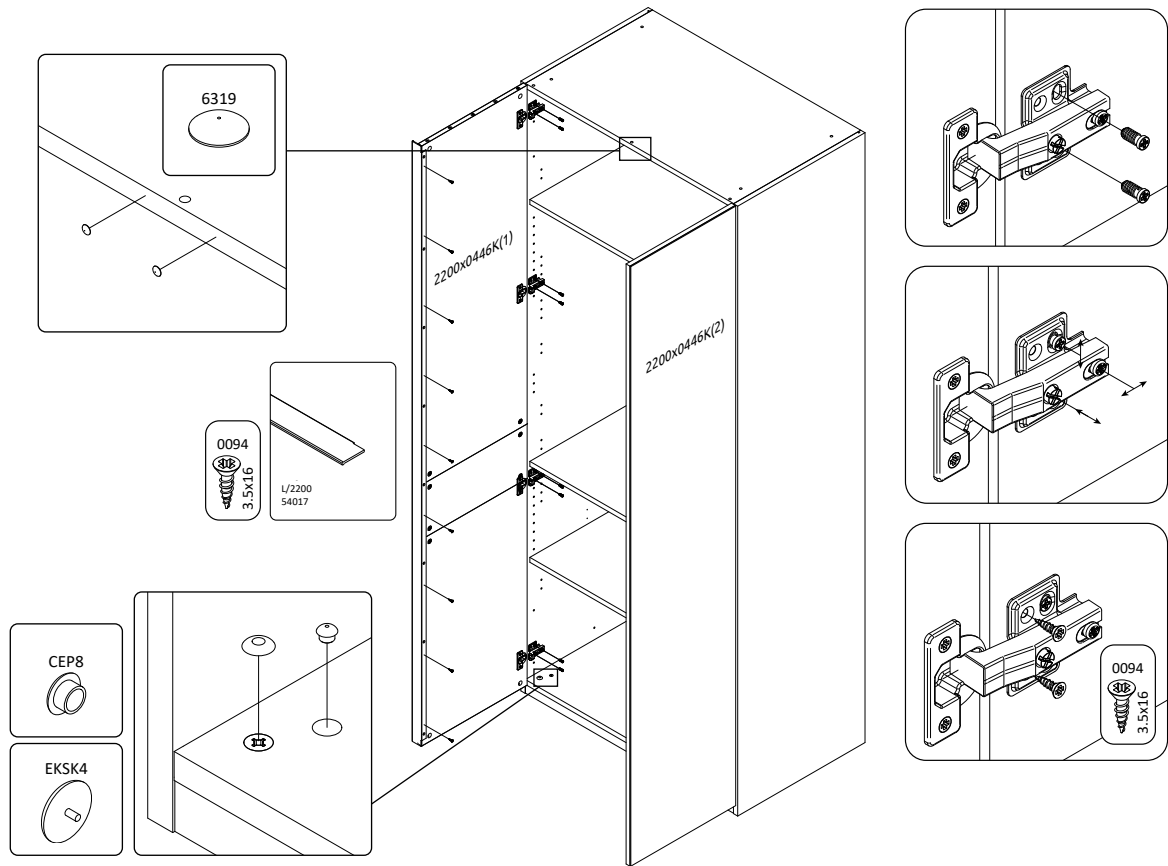

**\* OPT - P2-20G**

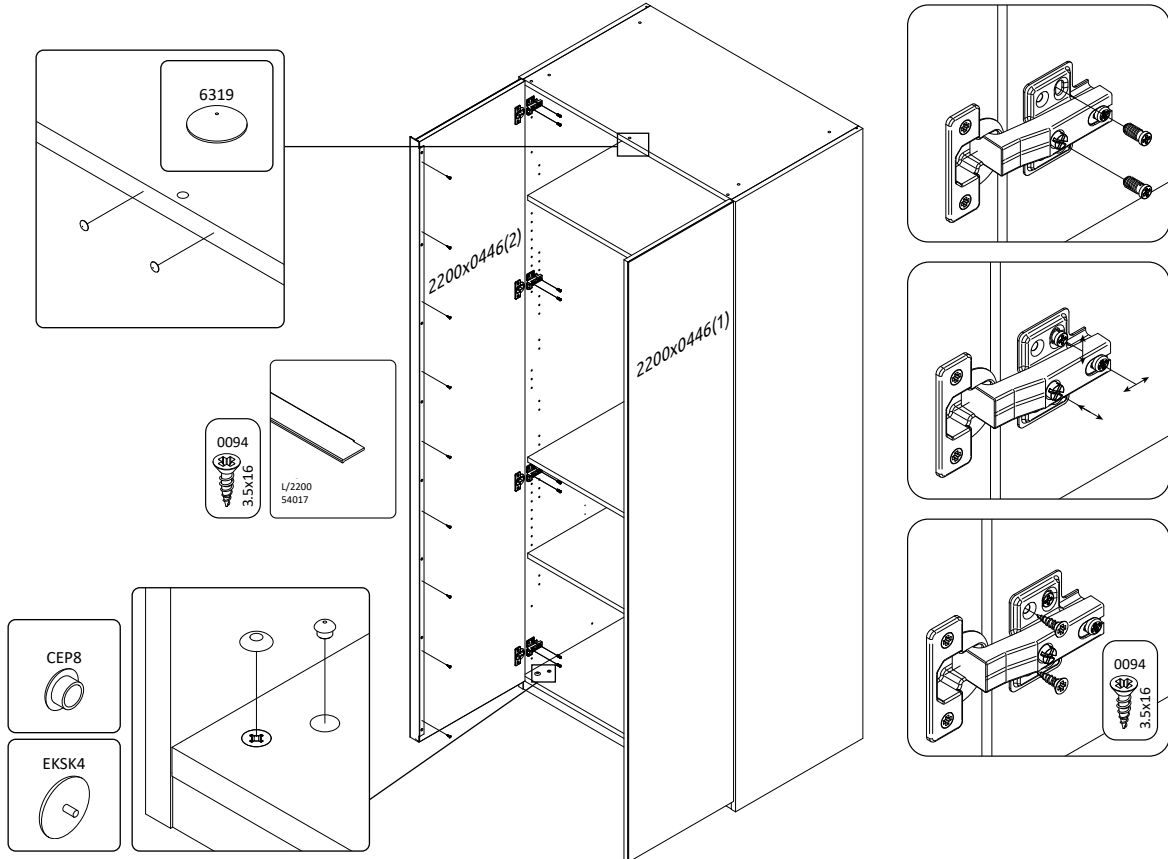

P2-10G

